



matteolighting.com
info@matteolighting.com

Toll: 1 844 628 8368
Tel: 604 560 5136

Canada: 100-1873 Forge Place Abbotsford, BC V2T 0L2
USA: 6875 Speedway Blvd. Ste 106 Las Vegas, NV 89115

Project: _____

Company: _____

Location: _____ SPEC #: _____

Approved On: _____ Approved By: _____



WALL SCONCE

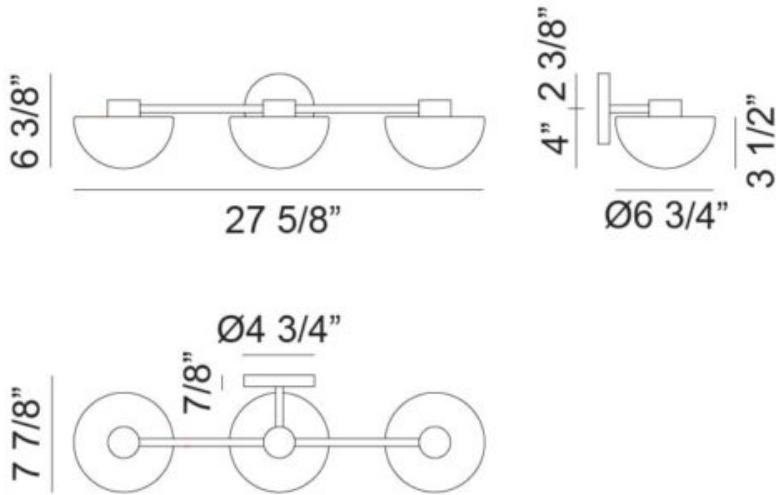

Description

GARDENA

Sculptural simplicity meets warm contemporary style. Featuring a sleek linear frame in a rich Champagne Gold and Matte Black finish, the design is elevated by softly curved opal glass shades that diffuse light beautifully for a warm, inviting glow. The asymmetrical arm arrangement adds visual movement while maintaining a clean, balanced silhouette perfect for modern dining rooms, kitchens, and open living spaces.

W43703MBOP

Specifications

FINISH	Matte Black
SHADE	Opal Glass
SHADE DIMENSION	Ø6 3/4" x 3 1/2"H
DIMENSION	27 5/8"W x 6 3/8"H x 7 7/8"E
LAMPING	3x10W LED G9 120V
CANOPY COLOR	Matte Black
CANOPY SIZE	Ø4 3/4" x 7/8"H
LOCATION	Dry
WARRANTY	1 year fixture warranty

Notes