



matteolighting.com
info@matteolighting.com

Toll: 1 844 628 8368
Tel: 604 560 5136

Canada: 100-1873 Forge Place Abbotsford, BC V2T 0L2
USA: 6875 Speedway Blvd. Ste 106 Las Vegas, NV 89115

Project: _____

Company: _____

Location: _____ SPEC #: _____

Approved On: _____ Approved By: _____



Chandelier

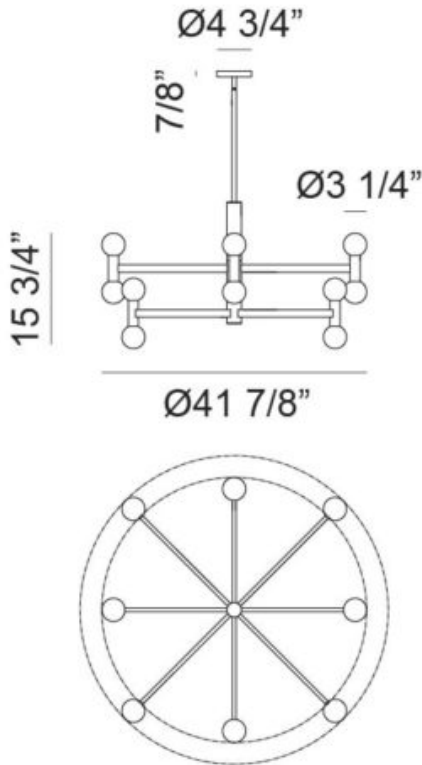

Description

INTERSTELLAR

Create a bold contemporary statement with this striking multi-light Interstellar series family featuring a dynamic linear design and sophisticated Champagne Gold and Matte Black finish. Inspired by modern sculptural forms, this fixture combines clean geometric lines with softly glowing Opal glass globes to deliver both artistic style and functional illumination.

C44116CGOP

Specifications

FINISH	Champagne Gold
SHADE	Opal Glass
SHADE DIMENSION	Ø3 1/4"
DIMENSION	Ø41 7/8"x 15 3/4"H
LAMPING	16x10W LED G9 120V
CANOPY COLOR	Champagne Gold
CANOPY SIZE	Ø4 3/4" x 7/8"H
ROD LENGTH	42"(12"x3+6"x1)
WIRE LENGTH	120" Max
LOCATION	Dry
WARRANTY	1 year fixture warranty

Notes