

Assembly Instruction Sheet #S-1246W8 For Style 1246W8

Tools Required: Flathead screwdriver, Phillips screwdriver, pliers, wire cutters, wire strippers, electrical tape, safety glasses.

Light Source: (1) 12W LED 9W DIMMABLE (2700K, 3000K, 3500K, 4000K, 5000K)
Preparation: Identify and inspect all parts before beginning installation. Check package content list and diagrams below to be sure all parts are present. If any parts are missing or damaged, do not attempt to assemble, install, or operate the fixture. Contact customer service for replacement parts.

⚠ Warnings and Cautions

Turn off electricity at circuit breaker or main fuse box before installation. Consult a licensed electrician if in doubt. These instructions are provided for your safety. It is very important you read them completely before installing the fixture. We strongly recommend that a licensed, professional electrician perform the installation. Disconnect fixture from power source before replacing bulbs. Make sure bulbs are given sufficient time to cool before removal.

Package Contents

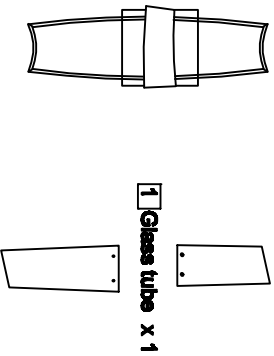

1 Fixture Body x1 2 Glass tube x 1

Hardware Contents

PART	DESCRIPTION	QUANTITY
BB	Wire nut	2pcs
CC	Screw	2pcs

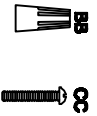

STEP 1 - The first step is to open the curved iron sheet. Then the glass is screwed on.

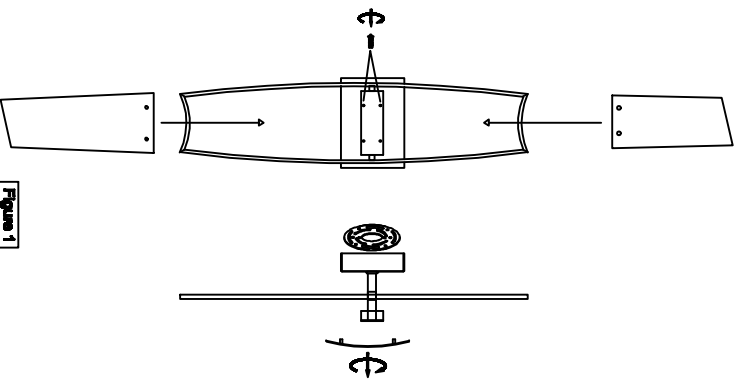

Figure 1

STEP 2 - Attach Mounting bracket to Outlet Box
 A. Pass the supply wires through the Mounting bracket (EE). Attach the Mounting bracket (EE) to the Outlet Box with the head of the Green Ground Screw facing you. Secure it with Outlet Box Screws. Tighten until snug.

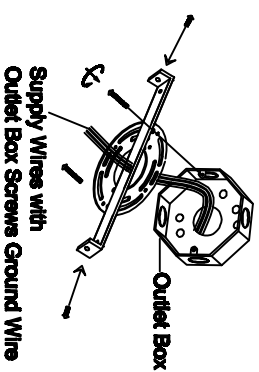

Figure 2

STEP 3 - Wire Connections

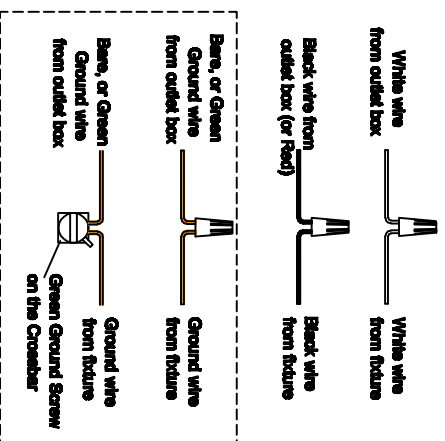

Figure 3

STEP 4 - Fix the iron plate with screws. Install Ceiling Canopy to Ceiling.

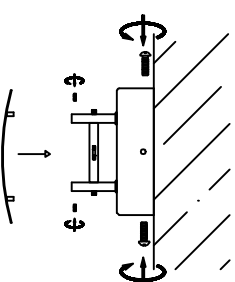

Figure 4

STEP 5 - Install tube.

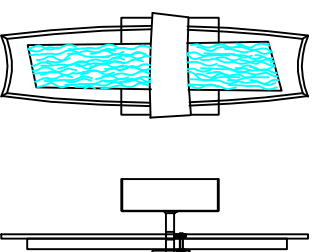

Figure 5