

Intelligent Touch Panel

[Bluetooth + DMX / Programmable]



UB1

UB2

UB4

UB5

Manual

www.ltech-led.com



Bluetooth®



(LED controllers)
E517856



RoHS



FCC ID:2AYCY-UB5

Product Introduction

Intelligent Touch Panel is an American base wall switch, integrating Bluetooth 5.0 SIG Mesh and DMX signals. It is a simple but elegant design with CNC aviation aluminum frame and 2.5D tempered glass. The panel is suitable for multi-scene and multi-zone lighting control applications. Working with Bluetooth systems makes it more convenient and intelligent.

Package Contents



Intelligent Touch Panel × 1



Manual × 1

Technical Specs

Model	UB1	UB2	UB4	UB5
Control mode	DIM	CT	RGBW	RGBWY
Input voltage	12-24VDC, Powered by Class 2			
Wireless protocol type	Bluetooth 5.0 SIG Mesh			
Output signal	DMX 512			
Zones	4			
Working temperature	-20°C~55°C			
Dimensions(L×W×H)	120×75×30(mm)			
Package size(L×W×H)	158×113×62(mm)			
Weight(G.W.)	225g			

Product Size

Unit: mm

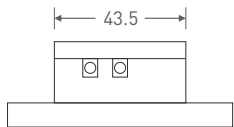
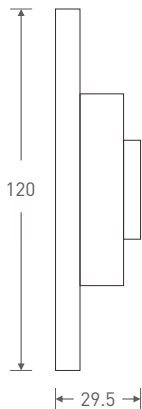
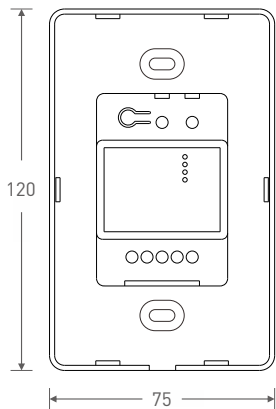

(Top View)

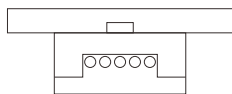

(Bottom View)

UB1

Brightness shortcuts
25% ,50% ,100%

Short press: All ON/OFF

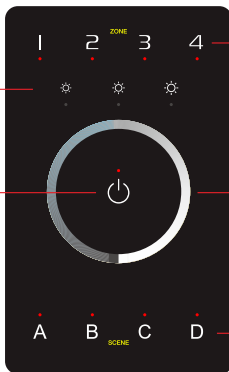

1- 4 Zone keys
Short press: Turn ON
Select/Deselect the zone
Long press: Turn OFF

Touch color circle (DIM)

4 Scene keys
Short press: Execute scene
Please refer to P12 for
more detailed instructions
Please refer to P12 to
save scenes

UB2

Color tone shortcuts
Cool white
Neutral white
Warm white

Short press: All ON/OFF

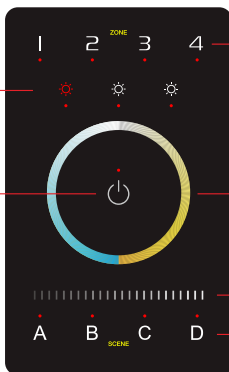

1- 4 Zone keys
Short press: Turn ON
Select/Deselect the zone
Long press: Turn OFF

Touch color circle (CT)

Touch slider bar (BRT)

4 Scene keys
Short press: Execute scene
Please refer to P12 for
more detailed instructions
Please refer to P12 to
save scenes

DMX address settings for CT:
Standard: Both channels are output CT values
Default: Set in the App
Please refer to P8 for more instructions

UB4

16 modes

Short press: Play mode

Long press: Adjust speed

Short press: ON/OFF RGB

Short press: All ON/OFF

16 modes (Press  to switch)

1. 3 color jumping
2. 7 color jumping
3. White strobe
4. 7 color strobe
5. Red green gradient
6. Red blue gradient
7. Green blue gradient
8. Red yellow gradient
9. Blue purple gradient
10. Green yellow gradient
11. Blue cyan gradient
12. Red purple gradient
13. Blue white gradient
14. Yellow purple cyan gradient
15. 3 color gradient
16. Full color gradient

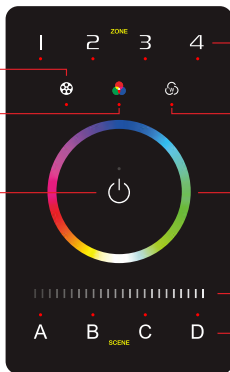

1- 4 Zone keys
Short press: Turn ON
Select/Deselect the zone
Long press: Turn OFF

Short press: Turn ON/OFF white color
Long press: Adjust brightness of white color

Touch color circle (RGB)

Touch slider bar (BRT)

4 Scene keys
Short press: Execute scene
Please refer to P12 for more detailed instructions
Please refer to P12 to save scenes

UB5

16 modes

Short press: Play mode

Long press: Adjust speed

Short press: ON/OFF RGB

Long press: Adjust RGB brightness

Short press: All ON/OFF

16 modes (Press  to switch)

1. 3 color jumping
2. 7 color jumping
3. White strobe
4. 7 color strobe
5. Red green gradient
6. Red blue gradient
7. Green blue gradient
8. Red yellow gradient
9. Blue purple gradient
10. Green yellow gradient
11. Blue cyan gradient
12. Red purple gradient
13. Blue white gradient
14. Yellow purple cyan gradient
15. 3 color gradient
16. Full color gradient

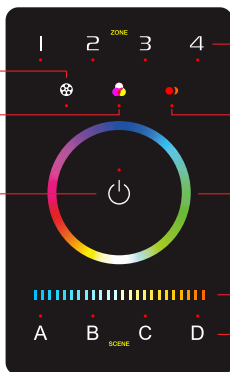

1- 4 Zone keys
Short press: Turn ON
Select/Deselect the zone
Long press: Turn OFF

Short press: Turn ON/OFF WY
Long press: Adjust brightness of WY

Touch color circle (RGB)

Touch slider bar (WY)

4 Scene keys
Short press: Execute scene
Please refer to P12 for more detailed instructions
Please refer to P12 to save scenes

1. Wireless Control.

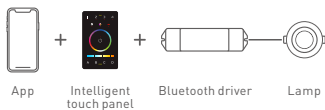

2. Wireless + Wired control (With reliable and stable signals).

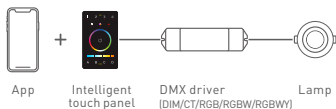

3. Wireless + Wired control (Enriching different lighting applications).

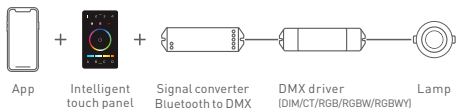

4. Visual control + Remote control of traditional panels.

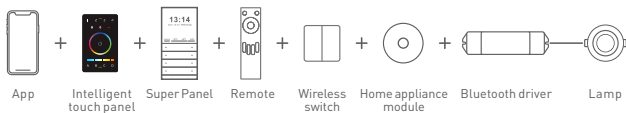

5. More applications of intelligent control are waiting for you to set up.

Bluetooth Application Diagram

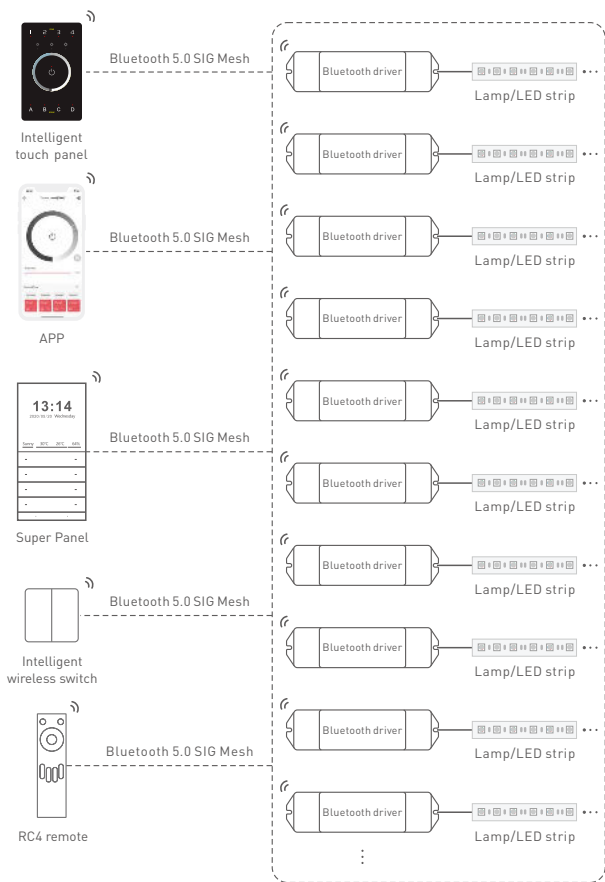

DMX Application Diagram

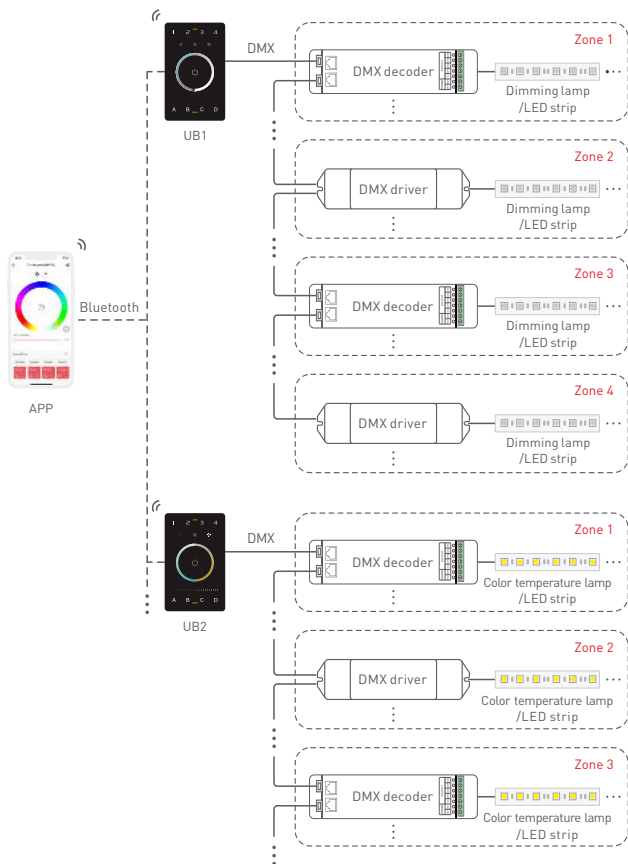

Each zone can be installed with multiple decoders. When the total number of decoders in 4 zones exceeds 32, please add DMX signal amplifiers.

DMX Channel Output Sheet

Address \ Type Zone	DIM	CT	CT2	RGBW	RGBWY
1	DIM1	C1	BRT1	R1	R1
2	DIM2	W1	CT1	G1	G1
3	DIM3	C2	BRT2	B1	B1
4	DIM4	W2	CT2	W1	W1
5	DIM1	C3	BRT3	R2	Y1
6	DIM2	W3	CT3	G2	R2
7	DIM3	C4	BRT4	B2	G2
8	DIM4	W4	CT4	W2	B2
9	DIM1	C1	BRT1	R3	W2
10	DIM2	W1	CT1	G3	Y2
11	DIM3	C2	BRT2	B3	R3
12	DIM4	W2	CT2	W3	G3
13	DIM1	C3	BRT3	R4	B3
14	DIM2	W3	CT3	G4	W3
15	DIM3	C4	BRT4	B4	Y3
16	DIM4	W4	CT4	W4	R4
17	DIM1	C1	BRT1	R1	G4
18	DIM2	W1	CT1	G1	B4
19	DIM3	C2	BRT2	B1	W4
20	DIM4	W2	CT2	W1	Y4
⋮	⋮	⋮	⋮	⋮	⋮
500	DIM4	W2	CT2	W1	Y4
⋮	⋮	⋮	⋮	⋮	/
512	DIM4	W4	CT4	W4	/

* As shown in the sheet above, every 4 DIM addresses are circulated in 4 zones, every 8 addresses of CT1 and CT2 are circulated in 4 zones, every 16 RGBW addresses are circulated in 4 zones, every 20 RGBWY addresses are circulated in 4 zones.

Step 1: Remove the panel plate with a flathead screwdriver, as shown below.

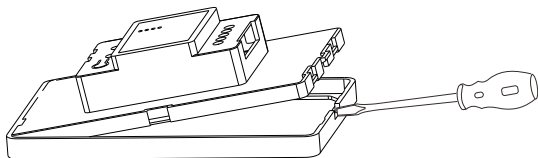

Step 2: Attach the wires to the panel, as shown in the diagram below . Please be sure to turn off the power to the circuit at the circuit breaker or fuse box before attaching the wires.

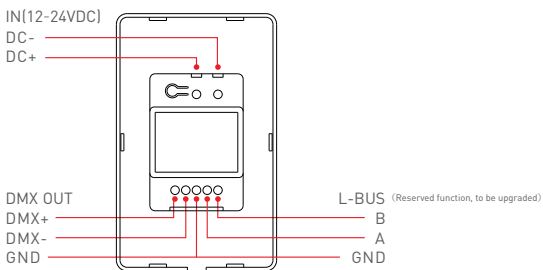

Step 3: Install the panel plate. Once the wires are attached correctly, you can gently fold any excess wire and compress the panel into the junction box. Tighten the screws to secure the panel plate to the box.

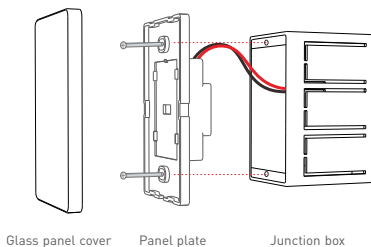

Step 4: Put the panel cover in place. Gently snap the panel cover onto the plate.

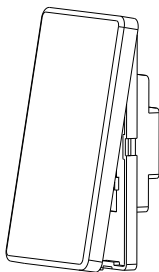

Attentions

- Please use in spacious and open space. Avoid metal obstructions above and in front of products.
- Please use in a cool and dry environment.
- No disassembly of products so as not to affect the warranty.
- Avoid direct contact with light and heat.
- Please do not open, modify, repair or maintain products without authorization, otherwise warranties are not allowed.

App Operating Instructions

1. Register an account

- 1.1 Scan the QR code below with your mobile phone and follow the prompts to complete the app installation.
- 1.2 Open the App and log in or register an account.



Scan and download the App

2. Pairing instructions

Create a home if you are a new user. Click “+” icon in the upper right corner and access the “Add device” list. Follow the prompts to add a LED driver first, then pick “LED controller-Touch panel” from the device list. Follow the prompts to activate the device, then click “Bluetooth search” to add the device.

How to reset the device to factory defaults: When the panel is powered on (the indicator light is white), long press Key A and Key D for 6s. If all the indicator lights of the panel flash several times, it means the device has been reset to factory defaults.

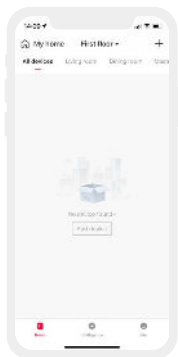

3. How to bind lights /light groups and save scenes

After pairing, get access to the control interface and choose the button for the zone lighting you are going to edit. You can bind lights and light groups to the buttons.

Local scenes: After adjusting the zone lighting to appropriate status, click "Save" and follow the prompts to save zone lighting status in the scene. After saving, click the corresponding scene button to execute the current local lighting scene (Supporting 16 scenes currently).

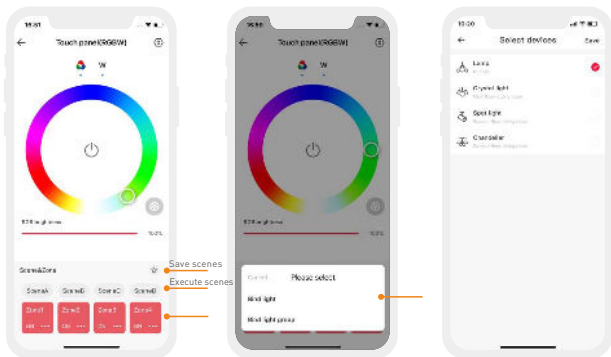

4. How to bind a bluetooth remote/bluetooth intelligent wireless switch

Please refer to the manual of a bluetooth remote / bluetooth intelligent wireless switch.

After adding the device, access the control interface and bind the corresponding intelligent touch panels.

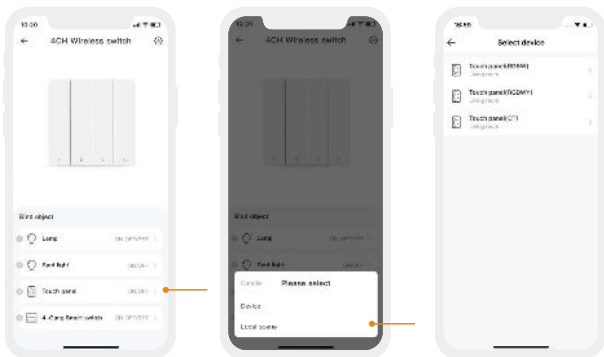

5.Normal modes and advanced modes

Normal modes: Click "Mode" icon and access the mode interface. Click the blank area of the mode and it can be executed. There are 12 editable normal modes in total which satisfy the general needs of customers(Currently, only RGBW & RGBWY support normal modes).

Advanced modes: Click the blank area of the mode and it can be executed. There are 8 editable advanced modes in total which satisfy the general needs of customers.

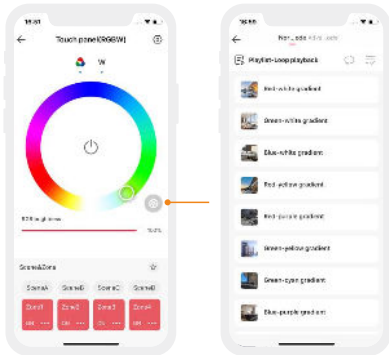

Edit modes: Switch to "Me" menu and click "Lighting mode settings". After selecting the light fixture type, click the blank area of mode to get access to the editable mode interface and edit it.

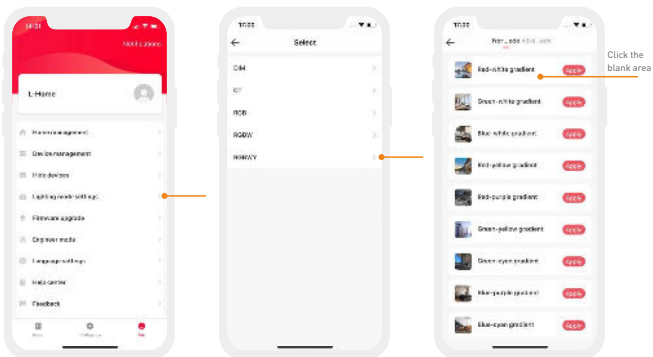

After complete editing, click “Apply” and the mode can be applied to the device.

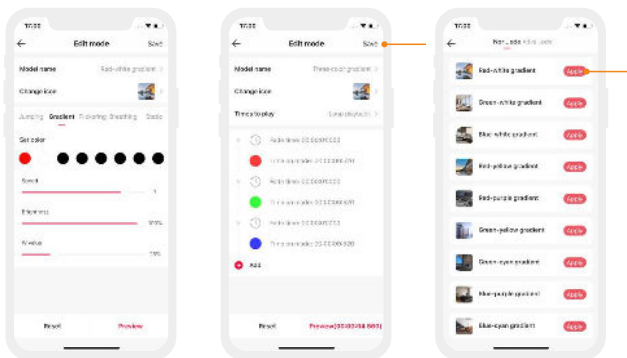

6.How to share control of your home

The home sharing mode adopted is able to share the home or transfer the home founder to other home members. Switch to “Me” menu and choose “Home management”. Click the home that you want to share and click “Add member”, then follow the prompts to complete the home sharing.

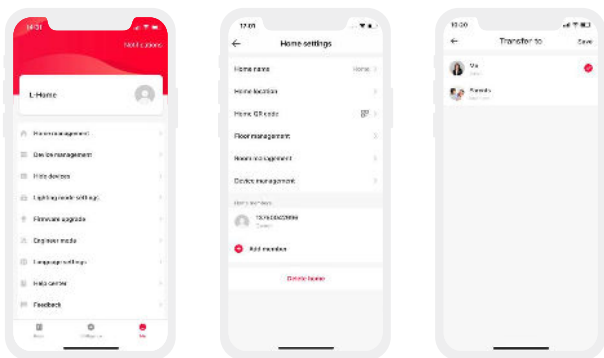

Changes or modifications to this unit not expressly approved by the party responsible for compliance could void the user's authority to operate the equipment.

This device complies with Part 15 of the FCC Rules.

Operation is subject to the following two conditions:

(1) This device may not cause harmful interference, and (2) this device must accept any interference received, including interference that may cause undesired operation.

Note: This equipment has been tested and found to comply with the limits for a Class B digital device, pursuant to part 15 of the FCC Rules. These limits are designed to provide reasonable protection against harmful interference in a residential installation. This equipment generates, uses and can radiate radio frequency energy and, if not installed and used in accordance with the instructions, may cause harmful interference to radio communications. However, there is no guarantee that interference will not occur in a particular installation. If this equipment does cause harmful interference to radio or television reception, which can be determined by turning the equipment off and on, the user is encouraged to try to correct the interference by one or more of the following measures:

- Reorient or relocate the receiving antenna.
- Increase the separation between the equipment and receiver.
- Connect the equipment into an outlet on a circuit different from that to which the receiver is connected.
- Consult the dealer or an experienced radio/TV technician for help.

To maintain compliance with FCC's RF exposure guidelines, the distance must be at least 20cm between the radiator and your body, and fully supported by the operating and installation configurations of the transmitter and its antenna(s).

* This manual is subject to changes without further notice. Product functions depend on the goods. Please feel free to contact our official distributors if you have any question.

Warranty periods from the date of delivery: 2 years.

Free repair or replacement services for quality problems are provided within warranty periods.

Warranty exclusions below:

- Beyond warranty periods.
 - Any artificial damage caused by high voltage, overload, or improper operations.
 - Products with severe physical damage.
 - Damage caused by natural disasters and force majeure.
 - Warranty labels and barcodes have been damaged.
 - No any contract signed by LTECH.
1. Repair or replacement provided is the only remedy for customers. LTECH is not liable for any incidental or consequential damage unless it is within the law.
 2. LTECH has the right to amend or adjust the terms of this warranty, and release in written form shall prevail.