

Incandescent Pendant

PD34612
INSTALLATION SHEET

START FROM HERE

- Make sure **POWER** is **COMPLETELY OFF** at the fuse box
- Have your fixture installed by a qualified licensed electrician
- Prepare everything in a clear area
- Wear gloves at all time during this installation
- Read instructions carefully before you start assembly
- Keep this installation sheet for future reference

Please Note:

- 120V input

Technical Support: 1-855-855-8926

1. Remove fixture from its original package
2. Separate mounting plate (1c) from canopy (2a) by removing canopy screws (2b)
3. Attach mounting plate (1c) to electrical junction box (1a) using junction box screws provided (1e) in hardware package
4. To change fixture height, shorten or lengthen wire by removing screw (2c) from canopy (2a) and push or pull wire to your desired length. Secure screw (2c) in canopy (2a) to lock wire in place
5. Make proper electrical connections (black to hot "L", white to neutral "N", ground to "GND") with wire nuts (1b) provided in hardware package
6. Insert bulb (4a) into fixture socket
7. Secure glass (3b) to fixture (3a) by threading clockwise
8. Attach canopy (2a) to mounting plate (1c) with canopy screws (2b)

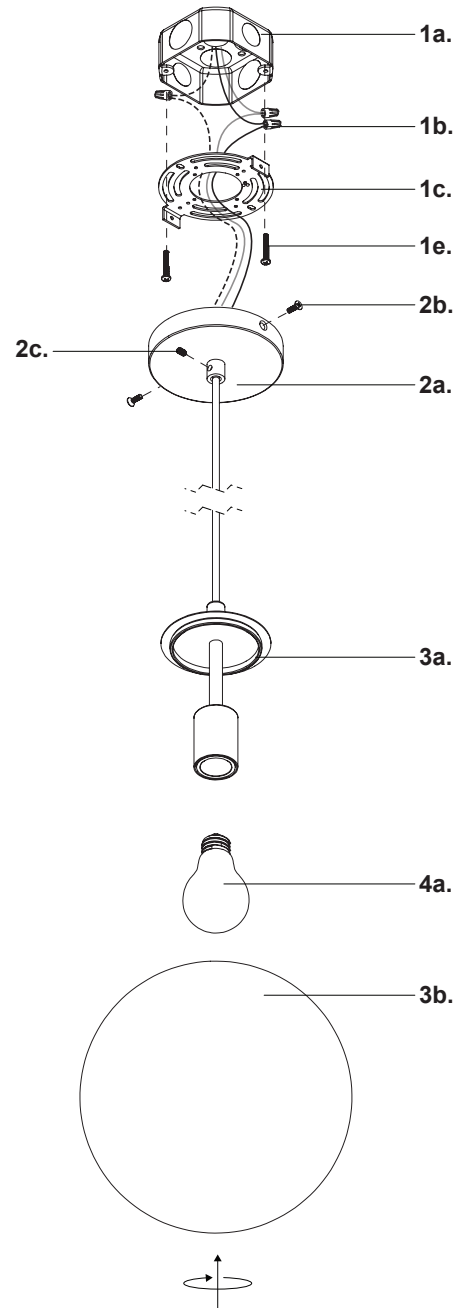

KUZCO

19054 28th Avenue Surrey, BC Canada V3Z 6M3
T: 604 538 7162 TF: 1-855 85 KUZCO F: 604 538 7196
W: kuzcolighting.com
20250107