

Installation guide for
Guide d'installation pour

dals

1 877 430 1818
www.dals.com

GRAVITY
DCP-GRD4-BK

Download the free Dals Connect app
Télécharger l'application gratuite Dals Connect



MODEL / MODÈLE	WATTS	LUMENS	KELVIN	INPUT / ENTRÉE	DIMMABLE*
DCP-GRD4	10W	515lm	RGB + CCT 2200-4000K	24VDC	✓

*Dals Connect App™ / Application Dals Connect™



Landscape transformer, model **DCP-TR60-BK**, **DCP-TR200-BK** or **DCP-PTR36** is required for installation. Sold separately.
Transformateur pour appareils d'éclairage paysager, modèle **DCP-TR60-BK**, **DCP-TR200-BK** ou **DCP-PTR36** est requis pour l'installation. Vendu séparément.

ITEMS INCLUDED IN THE BOX / ARTICLES INCLUS DANS LA BOÎTE

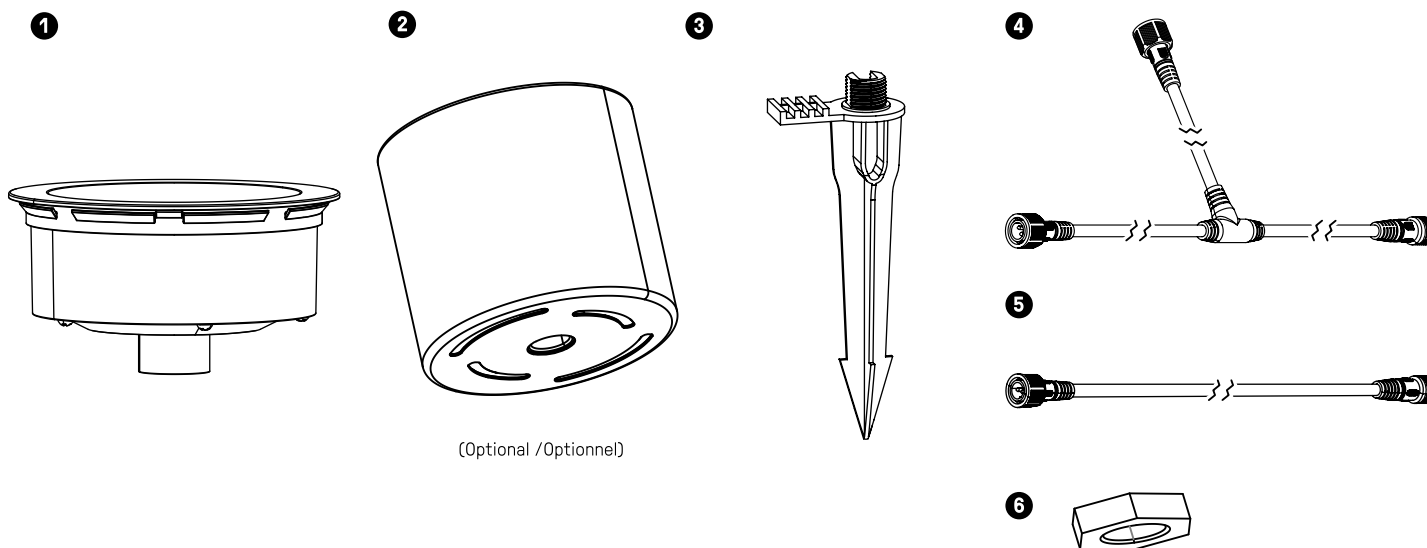

- 1 4" LED landscape ground light / Luminaire de sol DEL de 4"
- 2 Mounting can / Canne de montage
- 3 Ground stake / Piquet de terre
- 4 6" T-connector / Connecteur en T de 6"
- 5 6' Extension cable / Câble d'extension de 6'
- 6 Fixation nut / Écrou de fixation

COMPATIBLE ACCESSORIES (SOLD SEPARATELY):
ACCESSOIRES COMPATIBLES (VENDUS SÉPARÉMENT) :

- DCP-TR60-BK:** Transformer / Transformateur - Max. 60W
- DCP-TR200-BK:** Transformer / Transformateur - Max. 200W
- DCP-PTR36:** Plug-in driver / Transformateur enfichable - 36W
- DCP-ACC-MS12:** Metal ground stake 12" / Piquet de terre en métal 12"
- DCP-ACC-MS06:** 6" metal stake / Piquet de terre en métal de 6"
- DCP-ACC-MB:** Mounting bracket / Support de montage
- DCP-EXT20FT:** 20' extension cable / Câble d'extension de 20'
- DCP-EXT6FT:** 6' extension cable / Câble d'extension de 6'
- DCP-EXT-T:** 6" T-connector / Connecteur en T de 6"

WARRANTY / GARANTIE

DALS offers a 5 year warranty from the date of purchase which covers repairs or replacements of defective parts of the housing, optics, and electronics.
To contact DALS customer service call 1 877 430 1818 or send an e-mail to info@dals.com.

DALS offre une garantie de 5 ans à partir de la date d'achat qui couvre la réparation ou le remplacement des pièces du boîtier, ainsi que les pièces optiques et électroniques défectueuses. Pour contacter le service à la clientèle de DALS, composez le 1 877 430 1818 ou envoyez un courriel à info@dals.com.

Installation guide Guide d'installation

GRAVITY
DCP-GRD4-BK



BEFORE YOU START

BEFORE STARTING INSTALLATION, SHUT THE LINE FEED POWER OFF USING THE CIRCUIT BREAKER.
Instructions pertaining to a risk of fire, electric shock or injury to persons. Installation must be done according to local electrical codes.
Installation should be done by a certified electrician.



AVANT DE COMMENCER

AVANT DE DÉBUTER L'INSTALLATION, COUPER L'ALIMENTATION DU FIL DU SECTEUR À L'AIDE DU DISJONCTEUR.
Ces instructions se rapportent à un risque d'incendie, de chocs électriques ou de blessures corporelles.
L'installation doit être effectuée conformément aux codes électriques locaux. L'installation devrait être effectuée par un électricien qualifié.

Surface installation with can Installation en surface avec canne

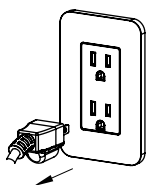

- 1 Make sure the power to the transformer is turned off.
S'assurer que l'alimentation du transformateur est coupée.

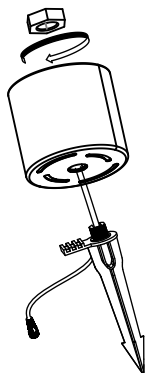

- 2 Position the wire through the can hole then secure the can on the stake with the included nut.
Positionner le fil dans le trou de la canne puis fixer le piquet à l'aide de l'écrou inclus.

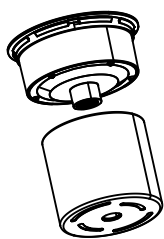

- 3 Place the fixture into the can by pressing firmly.
Insérer la lumière dans la canne en pressant fermement.

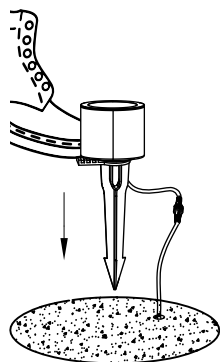

- 4 Press your foot on the pedal to insert the stake into the ground and connect the light.
Appuyer sur le piquet avec votre pied pour enfoncer celui-ci dans le sol et enficher la lumière.
- 5 Turn the power back on.
Rétablir le courant.

Recessed deck installation Installation régressée sur patio

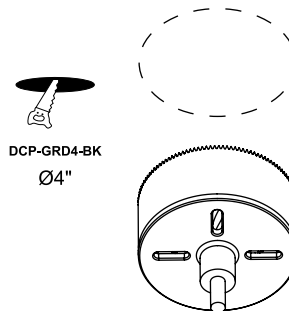

- 1 Cut a 4" diameter hole in your floor.
Découper un trou de 4" de diamètre dans votre plancher.

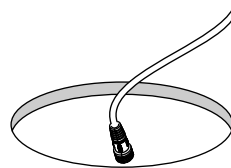

- 2 Pass the wire through the hole and make your connection.
Passer le fil dans le trou et faire la connexion rapide.

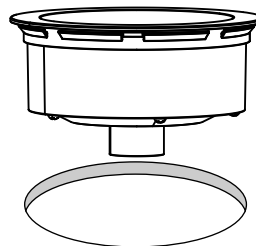

- 3 Insert the fixture in the hole and make a silicone joint (not included).
Insérer la lumière dans le trou et faire un joint en silicone (non-inclus).

Notice:
Can also be recessed in concrete or soil.
Peut aussi être régressé dans le ciment ou le sol.



Dals Connect

To pair your product, follow the steps on the App
Pour connecter votre produit, suivre les étapes sur l'application

dals

1 877 430 1818
www.dals.com
INS_DCP-GRD4

FCC COMPLIANCE

FCC STATEMENT

1. This device complies with Part 15 of the FCC Rules. Operation is subject to the following two conditions: (1) This device may not cause harmful interference, and (2) This device must accept any interference received, including interference that may cause undesired operation.
2. Changes or modifications not expressly approved by the party responsible for compliance could void the user's authority to operate the equipment.

This equipment has been tested and found to comply with the limits for a Class B digital device, pursuant to part 15 of the FCC Rules. These limits are designed to provide reasonable protection against harmful interference in a residential installation. This equipment generates, uses and can radiate radio frequency energy and, if not installed and used in accordance with the instructions, may cause harmful interference to radio communications. However, there is no guarantee that interference will not occur in a particular installation. If this equipment does cause harmful interference to radio or television reception, which can be determined by turning the equipment off and on, the user is encouraged to try to correct the interference by one or more of the following measures:

- Reorient or relocate the receiving antenna.
- Increase the separation between the equipment and receiver.
- Connect the equipment into an outlet on a circuit different from that to which the receiver is connected.
- Consult the dealer or an experienced radio/ TV technician for help.

FCC Radiation Exposure Statement:

This equipment complies with FCC radiation exposure limits set forth for an uncontrolled environment. In order to avoid the possibility of exceeding the FCC radio frequency exposure limits, Human proximity to the antenna shall not be less than 20cm (8 inches) during normal operation

IC COMPLIANCE

CANICES-5(*)/NMB-5(*)

Industry Canada Notice

This device contains licence-exempt transmitter(s)/receiver(s) that comply with Innovation, Science and Economic Development Canada's licence-exempt RSS(s). Operation is subject to the following two conditions:

- (1) This device may not cause interference.
- (2) This device must accept any interference, including interference that may cause undesired operation of the device

- 2.Changes or modifications not expressly approved by the party responsible for compliance could void the user's authority to operate the equipment.

CONFORMITÉ IC

Avis d'Industrie Canada

Cet appareil contient des émetteurs / récepteurs exemptés de licence conformes aux RSS (RSS)d'Innovation, Sciences et Développement économique Canada. Le fonctionnement est soumis aux deux conditions suivantes :

- (1) Cet appareil ne doit pas causer d'interférences.
- (2) Cet appareil doit accepter toutes les interférences, y compris celles susceptibles de provoquer un fonctionnement indésirable de l'appareil.

- 2.Cet appareil numérique ne dépasse pas les Rélements sur l'interférence radio par un appareil numérique de classe B stipulées dans les Règlement sur l'Interférence radio d'industrie Canada.

ISED RF Exposure statement

This equipment complies with ISED radiation exposure limits set forth for an uncontrolled environment. In order to avoid the possibility of exceeding the ISED radio frequency exposure limits, Human proximity to the antenna shall not be less than 20cm (7.9 inches) during normal operation