

WARNINGS



RISK OF FIRE, ELECTRICAL SHOCK, CUTS OR OTHER CASUALTY HAZARDS

Installation and maintenance of this product must be performed by a qualified electrician. This product must be installed in accordance with the applicable installation code by a person familiar with the construction and operation of the product and hazards involved.

RISK OF FIRE AND ELECTRIC SHOCK

Make certain power is OFF before starting installation or attempting any maintenance. Disconnect power at fuse or circuit breaker.

RISK OF FIRE

Refer to product label for specific minimum supply conductor requirements.

RISK OF BURN

Disconnect power and allow fixture to cool before handling or servicing.

RISK OF PERSONAL INJURY

Fixture may become damaged and/or unstable if not installed properly.

DISCLAIMER OF LIABILITY: CSC LED assumes no liability for damages or losses of any kind that may arise from the improper, careless, or negligent installation, handling or use of this product.

NOTICE: Green ground wire is provided in proper location. Do not relocate.

SAFETY: This fixture must be wired in accordance with the National Electrical Code and applicable local codes and ordinances. Proper grounding is required to ensure personal safety. Carefully observe grounding procedure under installation section.

APPLICATIONS: This lighting fixture is designed for indoor lighting applications, and should not be used in an area with limited ventilation or inside high ambient temperature enclosures. It must be stored in a dry location prior to installation.

ATTENTION RECEIVING DEPARTMENT: Note actual fixture description of any shortage or noticeable damage on delivery receipt. File claim for common carrier (LTL) directly with carrier. Claims for concealed damage must be filed within 15 days of delivery. All damaged material, complete with original packaging must be retained.

SURFACE MOUNT INSTALLATION

1. Drill holes and insert the anchor sleeves (Fig. 1).
2. Open the fixture by pressing both buttons located on opposite ends (Fig. 2).
3. Run the fixture power wires through the center hole of the round J-box adapter. Slide and secure the round J-Box adapter on the center slots located on the back of the fixture. Note: J-Box adapter is used to cover the Junction Box (Fig. 3).
4. Turn off the power and connect wiring by using wire nuts according to the wiring diagram (Fig. 4).
5. Secure the fixture to the wall with the correct mounting hardware (Fig. 5).
6. Attach the housing cover back onto the fixture (Fig. 6).
7. The installation is now complete. If disassembly is required, push both buttons located on the opposite ends of the fixture (Fig. 6).

2' Strip Light	LF = 12.55"
4' Strip Light	LF = 36.22"
8' Strip Light	LF = 83.38"

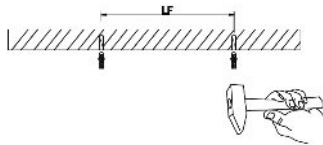

Fig. 1



Fig. 2

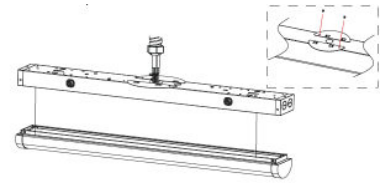

Fig. 3

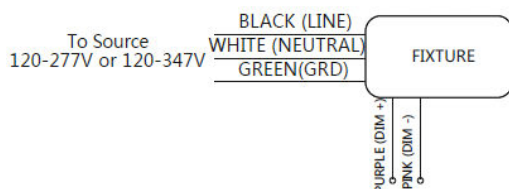

Fig. 4

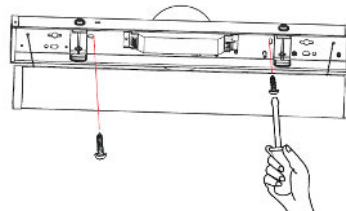

Fig. 5

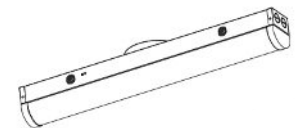
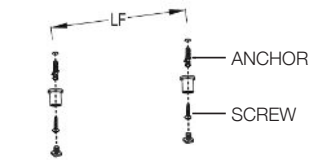

Fig. 6

SUSPENDED INSTALLATION

1. Drill holes in the ceiling and insert the hardware (Fig. 7).
2. Adjust the length of the hanging cable (Fig. 8).
3. Use M5 square screw and M5 fixed head to secure fixture (Fig. 9).
4. Turn off the power and connect wiring by using wire nuts according to the wiring diagram (Fig. 4) (See reverse).
5. Insert the terminal block and wires into the housing (Fig. 10).
6. Attach the housing cover back onto the fixture (Fig. 11).
7. The installation is now complete. If disassembly is required, push both buttons located on the opposite ends of the fixture (Fig. 12).



2' Strip Light	LF = 12.55"
4' Strip Light	LF = 36.22"
8' Strip Light	LF = 83.38"

Fig. 7

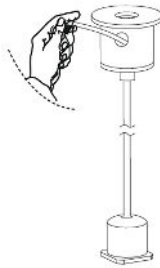

Fig. 8

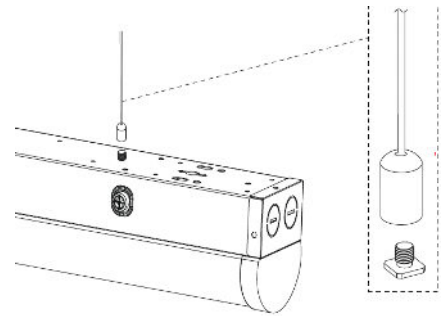

Fig. 9

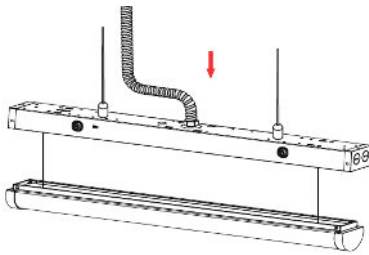

Fig. 10

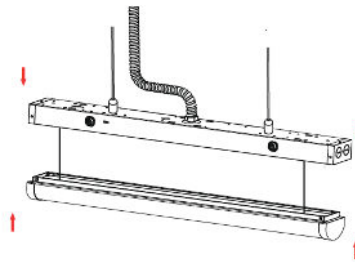

Fig. 11

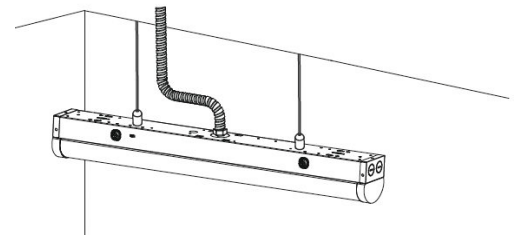

Fig. 12

CONTINUOUS ROW MOUNTING (SURFACE MOUNTED)

1. Turn power off.
2. Remove the knockout at the end of housing (Fig. 13).
3. Drill holes at a suitable position on the wall and insert the anchor sleeves into the wall (Fig. 14).
4. Use a screwdriver to tighten the screws to affix the fixture to the wall (Fig. 15).
5. Slip the connecting bracket under the strip light, leaving half of it exposed. (Fig. 16).
6. Insert the next fixture onto the connection bracket, then drill holes suitable position in the wall for installing the next strip light (Fig 17).
7. Affix the fixture on the wall with screws to complete the installation; repeat the previous procedure to install the 3rd strip light, 4th strip light etc. (Fig. 18 & 19).

* See next page for figures

8. Take the black/white/green wire harness and connect to the existing wire connectors on the input wires of the driver respectively. When using the dimming function, take the purple and pink wire harness and make connection to the driver (Fig. 19 & 20).
9. Insert the same type of electronic wires into the same wire nut and combine into a parallel circuit. Please note that the wires in the luminaire is 18 AWG.
10. Once wiring is completed, take wire harness and run it through the knockouts of the connecting fixture. Use self-adhesive cable ties to eliminate any tangles (Fig. 21).
11. Secure the housing cover by pressing inward and lock it into the fixture. Turn power on to verify operation (Fig. 22).

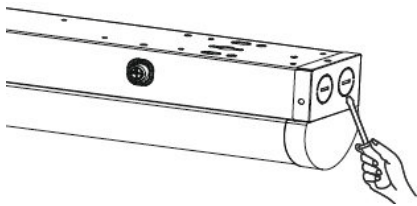

Fig. 13

2' Strip Light	LF = 12.55"
4' Strip Light	LF = 36.22"
8' Strip Light	LF = 83.38"

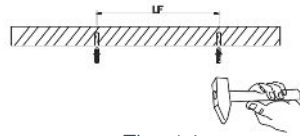

Fig. 14

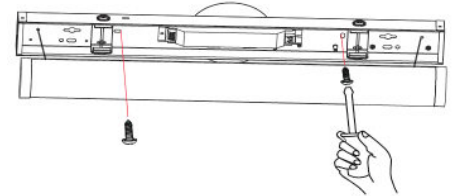

Fig. 15

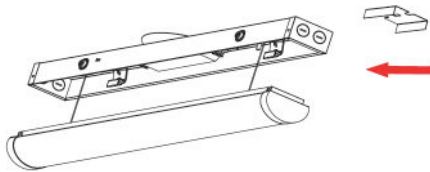

Fig. 16

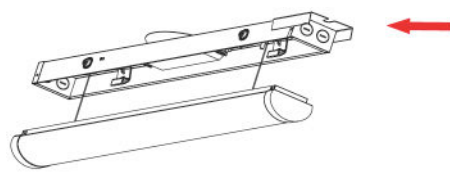

Fig. 17

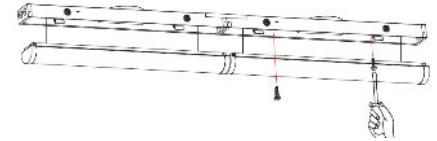

Fig. 18

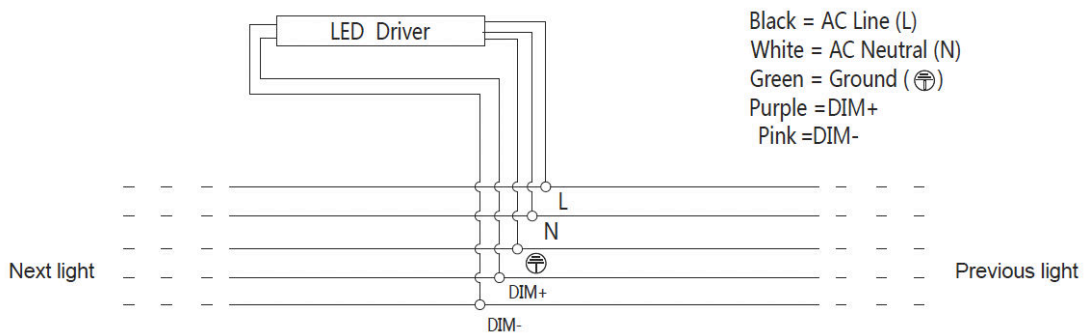

Fig. 19

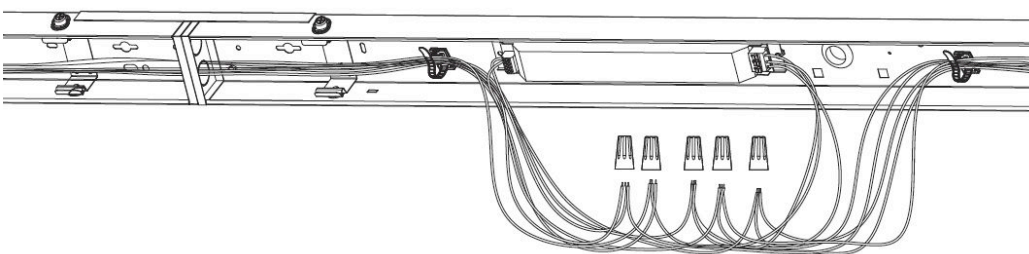

Fig. 20

Product	Max. qty recommended for row mounting
2' Strip Light	28
4' Strip Light	14
8' Strip Light	8

*This recommendation is based on the maximum current rating for 18 AWG wires which carry the load for row mounting.

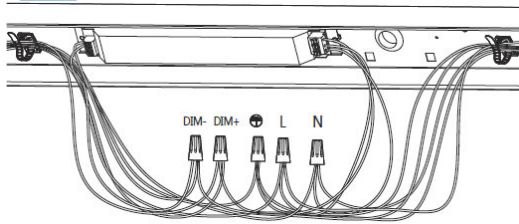

Fig. 21

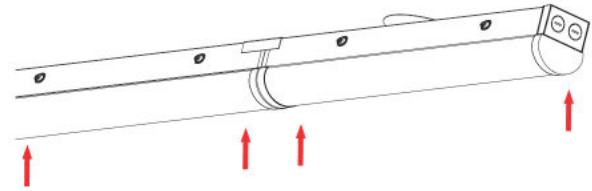

Fig. 22

CONTINUOUS ROW MOUNTING (SUSPENDED)

1. Turn power off.
2. Remove the knockout at the end of the housing (Fig. 23).
3. Install the connection bracket at the end of one fixture with screw (Fig. 24).
4. Secure the connection bracket on the other end to another fixture (Fig. 25).
5. Drill holes in the wall and install the hardware (Fig. 26).
6. Adjust the length of the safety cable after locked (Fig. 27).
7. Remove the cover and use M5 square screw and M5 fixed head to secure fixture (Fig. 29).
8. Finish the safety rope installation (Fig. 29).
9. Install all required fixtures following steps 1 through 8.
10. Press the buttons on both sides of the fixtures to remove housing cover.
11. Take the black/white/green wire harness and connect to the existing wire connectors on the input wires of the driver respectively. When using the dimming function, take the purple and pink wire harness and make connection to the driver (Fig. 19 & 20).
12. Insert the same type of electronic wires into the same wire nut and combine into a parallel circuit. Please note that the wires in the luminaire is 18 AWG.
13. Once wiring is completed, take wire harness and run it through the knockouts of the connecting fixture. Use self-adhesive cable ties to eliminate any tangles (Fig. 21).
14. Secure the housing cover by pressing inward and lock it into the fixture. Turn power on to verify operation (Fig. 30).

Product	Max. qty recommended for row mounting
2' Strip Light	28
4' Strip Light	14
8' Strip Light	8

*This recommendation is based on the maximum current rating for 18 AWG wires which carry the load for row mounting.

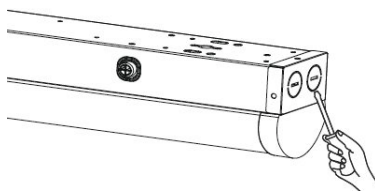

Fig. 23

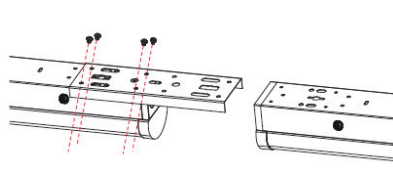

Fig. 24

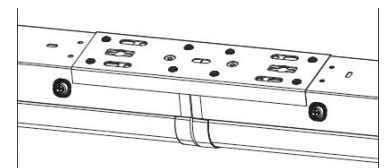

Fig. 25

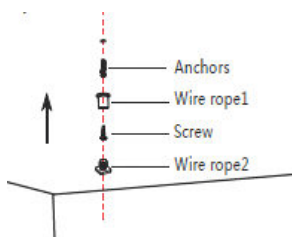

Fig. 26

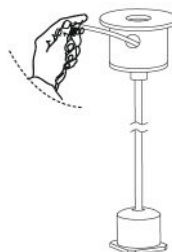

Fig. 27

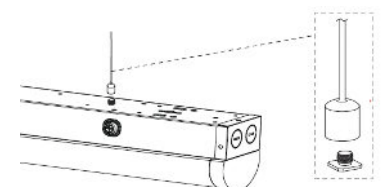

Fig. 28

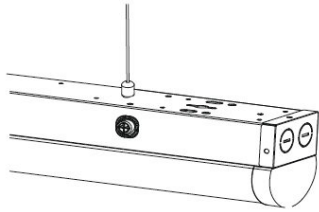

Fig. 29

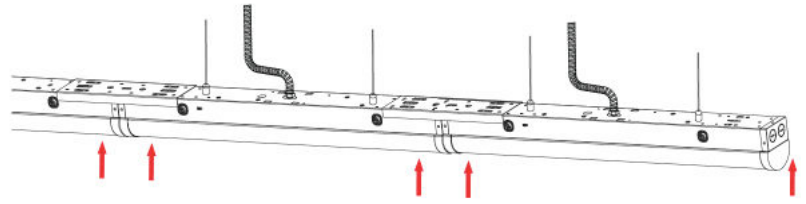

Fig. 30

CONTINUOUS ROW MOUNTING (MALE AND FEMALE CONNECTORS)

1. Press the buttons on both sides to release the strip light cover (Fig. 31).
2. Remove the screws of end caps, and take off the end caps from the strip light (Fig. 32).
3. Install the new end caps (with male and female connectors) on the strip light, and secure the end caps with screws (Fig. 33).
4. Connect the wires with wiring nuts (Fig. 34). Please note that the wires in the luminaire is 18 AWG.
5. Attach the housing cover back onto the fixture. It should be locked in place with the springs installed in the fixture (Fig. 35).
6. Installation complete (Fig. 36).

****Excludes 2 ft fixtures**

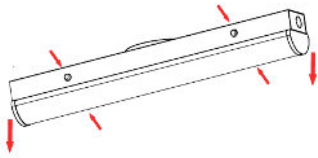

Fig. 31

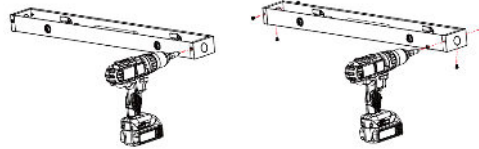

Fig. 32

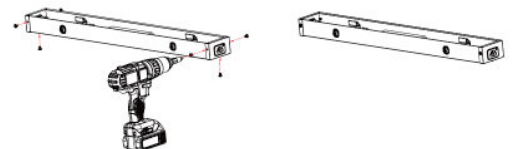

Fig. 33

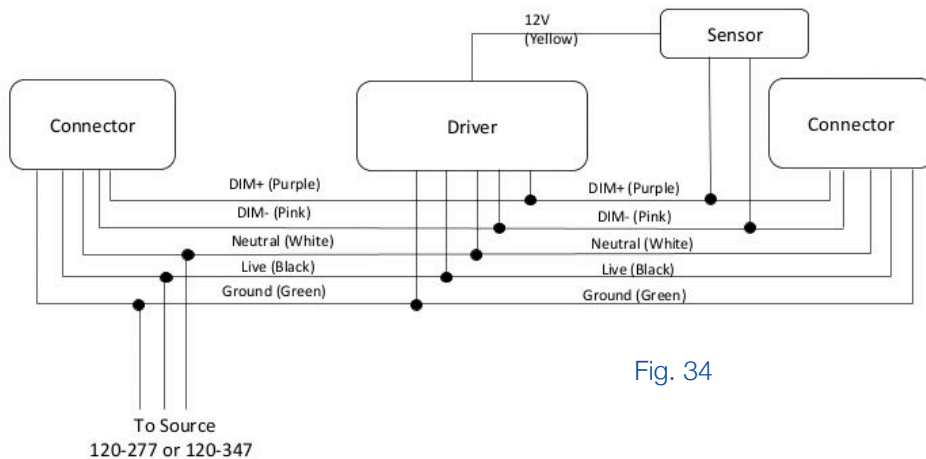

Fig. 34

NOTE: Sensor and power source only needs to be connected to first fixture



Fig. 35

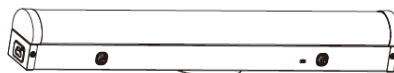

Fig. 36

Product	Max. qty recommended for row mounting
2' Strip Light	28
4' Strip Light	14
8' Strip Light	8

*This recommendation is based on the maximum current rating for 18 AWG wires which carry the load for row mounting.

HOW TO CHANGE POWER SELECTION AND COLOUR TEMPERATURE SETTINGS

1. Press buttons on both sides of the fixture to remove housing cover (Fig. 37).
2. Select your desired power and colour temperature settings using the switch on the driver (Fig. 38).

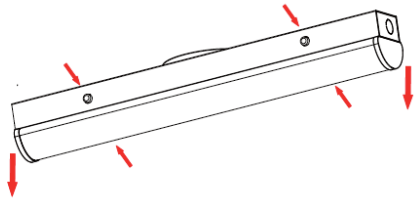

Fig. 37

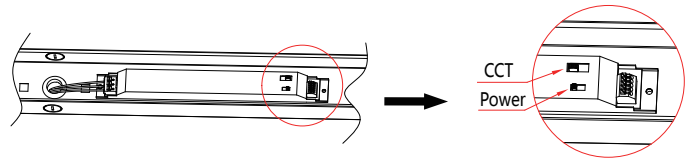

Fig. 38