

LED Exterior Wall Sconce

EW78513
INSTALLATION SHEET

START FROM HERE

- Make sure **POWER** is **COMPLETELY OFF** at the fuse box
- Have your fixture installed by a qualified licensed electrician
- Prepare everything in a clear area
- Wear gloves at all time during this installation
- Read instructions carefully before you start assembly
- Keep this installation sheet for future reference

Technical Support: 1-855-855-8926

Please Note:

- This Kuzco LED fixture comes with pre-wired LED module(s)
- Unless instructed, Do Not touch any part of the LED module(s) as any unnecessary contact with the module could cause permanent damage
- For dimming, an ELV (Electronic Low Voltage) type of dimmer is required
- 120V input

1. Remove fixture from its original package
2. Separate mounting plate (1c) from canopy (2a) by removing canopy screws (2b)
3. Attach mounting plate (1c) to electrical junction box (1a) using junction box screws provided (1e) in hardware package
4. Make proper electrical connections (**black to hot** "L", **white to neutral** "N", **ground to "GND"**) with wire nuts (1b) provided in hardware package
5. Attach canopy (2a) to mounting plate (1c) with canopy screws (2b)
6. Secure glass (3b) to fixture (3a) by threading clockwise
7. To prevent moisture from entering the electrical junction box (1a) and causing a short, seal around the top and side perimeter between the fixture and the wall surface with weather resistant caulking (See Illustration 1). The space at the bottom should be left un-caulked to prevent moisture build up

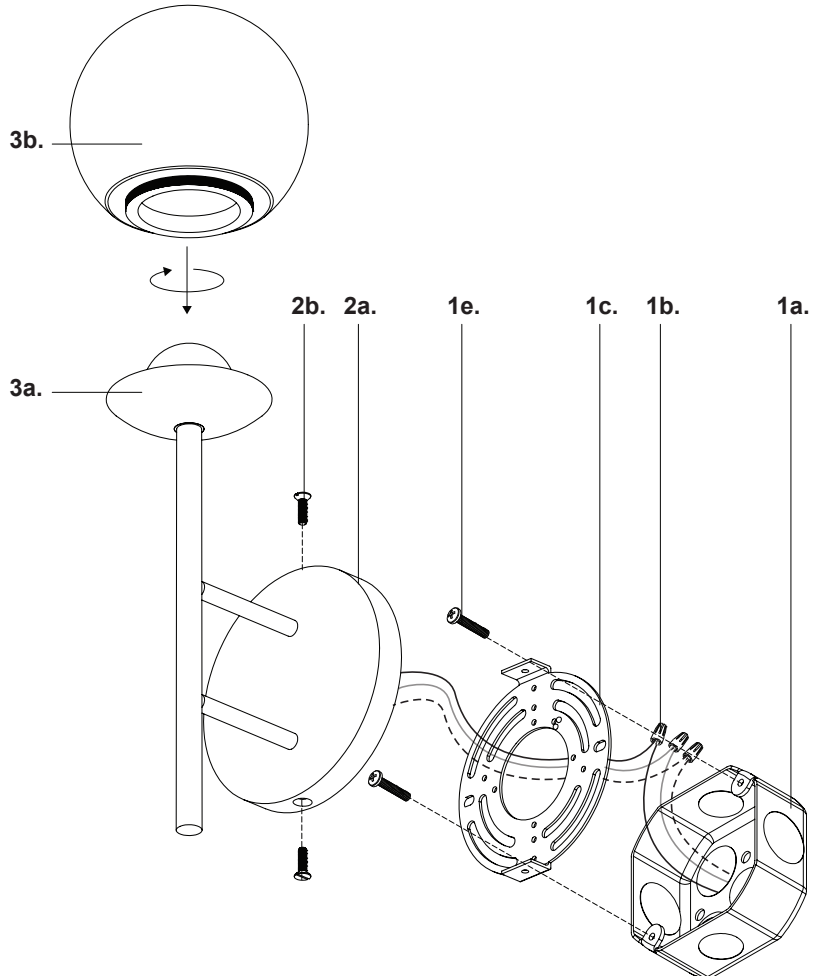
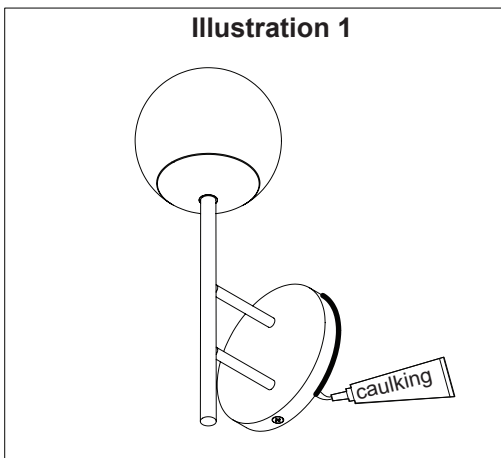

Illustration 1



KUZCO

19054 28th Avenue Surrey, BC Canada V3Z 6M3
T: 604 538 7162 TF: 1-855 85 KUZCO F: 604 538 7196
W: kuzcolighting.com
20240109