

WALL WASH

5821

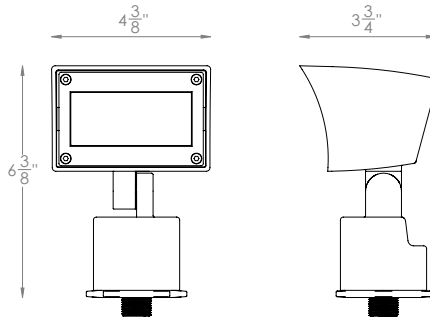

Fixture Type:

Catalog Number:

Project: _____

Location: _____

PRODUCT DESCRIPTION

Dynamic, eye-catching stunning vignettes. Celebrate artful illumination with new COLORSCAPING Wall Wash and Accent Lights from WAC Landscape Lighting. Heighten drama to render visual impact on magnificent tree trunk and branch silhouettes, brilliant colorful scenery on your hedgerow, or a swath of light washing a facade. Customize your experiences and enjoy your passion for color and the language of light with unbridled enthusiasm and a nearly endless palette. The possibilities are endless.

SPECIFICATIONS

Input: 15VAC (Colorscaping Smart Transformer is required)
Power: 16W / 24.5VA
Brightness: White: 1015
Red: 360
Green: 680
Blue: 140
Beam Angle: 50° by 80°
CRI: 85
Rated Life: 50,000 hours

FEATURES

- Each fixture can be individually controlled
- Fixtures can be grouped and controlled together
- Fixtures contain discrete, warm, and a cool white LEDs for full tunability
- Fixtures can generate tens of thousands of different colors
- Automations can be stored and recalled for holiday or other celebratory lighting scenes
- Fixtures from multiple transformers can be controlled as a single group in the app
- Integrators can control the fixtures using industry standard DMX 512
- The colorscaping transformer allows for installation growth - each transformer supports one or two legacy landscape lighting circuits in addition to the color scaping fixtures
- Paint your landscaping and home using light
- Schedule your landscape lighting based on sunrise and sunset in your location
- RGBWW Color Changing Fixture: R / G / B / 2700K-6500K

ORDERING NUMBER

		Color Temp	Finish
5821	<i>Wall wash</i>	CS <i>Color Changing</i>	BK <i>Black on Aluminum</i> BZ <i>Bronze on Aluminum</i> BBR <i>Bronze on Brass</i>

5821-_____

Example: 5821-CSBK

wacighting.com
Phone (800) 526.2588
Fax (800) 526.2585

Headquarters/Eastern Distribution Center
44 Harbor Park Drive
Port Washington, NY 11050

Central Distribution Center
1600 Distribution Ct
Lithia Springs, GA 30122









Western Distribution Center
1750 Archibald Avenue
Ontario, CA 91761

WALL WASH

5821



Accessories

Additional Stake		9000-ST9-BZ	Bronze	Durable PVC stake
Surface Mount Flange/Stake		5000-SCP-BK 5000-SCP-BZ 5000-SCP-BBR	Black on Aluminum Bronze on Aluminum Bronze on Brass	Includes three 7 inch threaded stainless steel stabilizing pins for ground mounting or surface mounts with four screws or over a junction box
Guardian Mount		9000-SP9-BZ	Stainless Steel	Heavy duty stainless steel spike to position fixture Formed from a single piece of metal
Gutter Mount Bracket		5000-GM-BZ 5000-GM-BK	Stainless Steel	Stainless Steel universal mounting bracket for gutter mounting fixture
Extension Rods		5000-X04-BZ 4 in 5000-X04-BK 4 in 5000-X04-BBR 4 in 5000-X08-BZ 8 in 5000-X08-BK 8 in 5000-X08-BBR 8 in 5000-X12-BZ 12 in 5000-X12-BK 12 in 5000-X12-BBR 12 in	5000-X18-BZ 18 in 5000-X18-BK 18 in 5000-X18-BBR 18 in 5000-X24-BZ 24 in 5000-X24-BK 24 in 5000-X24-BBR 24 in	Extends distance between Accent light and Surface Mount Canopy, Stake, or Tree Mount box
Rod L-Coupler		5000-LCO-BZ	Bronze	
Tree Mount Junction Box		5000-TCP-BK 5000-TCP-BZ	Black on Aluminum Bronze on Aluminum	Aluminum box with stainless steel mounting screws; two 1/2" NPT threaded holes, UL 120V listed
		5000-TCL-BK 5000-TCL-BZ	Black on Aluminum Bronze on Aluminum	Large aluminum box with stainless steel mounting screws; two 1/2" NPT threaded holes, UL 120V listed
Large Tree Mount Canopy Strap		5000-TST-BK	BK - Black in Stainless Steel	Ratcheting device with strap to be used with Large Tree Mount Junction Box (5000-TCL)
		5000-STB-BK	BK - Black in Stainless Steel	Tree mount bracket only

Magnetic Transformers

Stainless Steel, 15V output, IP65 rated, UL 1838 listed
See transformer spec sheet for details and its accessories

8150CS-TRN-SS
150W Max

8300CS-TRN-SS
300W Max



wacighting.com
Phone (800) 526.2588
Fax (800) 526.2585

Headquarters/Eastern Distribution Center
44 Harbor Park Drive
Port Washington, NY 11050

Central Distribution Center
1600 Distribution Ct
Lithia Springs, GA 30122

Western Distribution Center
1750 Archibald Avenue
Ontario, CA 91761