

Verona Round

Surface Mount

14", 18", 24", 35", 47"

Installation Guide



IMPORTANT SAFETY INSTRUCTIONS

1. Read carefully before installing fixture. Retain for future reference.

WARNING To prevent electrical shock, turn off electricity at fuse box before proceeding.

2. Failure to follow instructions may result in serious injury or death.

3. Upon receipt the fixture, thoroughly inspect for any freight damage which should be brought to the attention of the delivery carrier. Compare the catalog description listed on the package slip with the fixture label on the housing to assure you have received material.

4. This fixture must be wired in accordance with the international electrical code and applicable local codes and ordinances. Proper grounding is required to insure personal safety. Carefully observe the correct grounding procedure under installation section.

*Gleaming assumes no responsibility for claims arising out of improper or careless handling or installation of this product.

Uplight Switchable-14", 18", 24", 35", 47" Verona

Uplight Switchable	On	Off
Lighting Distribution	Indirect/Direct	Only Direct

CCT Selectable-14", 18", 24", 35", 47" Verona

CCT Selectable	3000K	3500K	4000K
----------------	-------	-------	-------

Wattage Adjustable-14", 18", 24", 35", 47" Verona

14" Verona

Output Current	500mA	600mA	700mA
Wattage Adjustable	22W	25W	28W

24" Verona

Output Current	1300mA	1400mA	1500mA
Wattage Adjustable	55W	59W	62W

35" Verona

Output Current (Driver 1)	1300mA	1400mA	1500mA
Output Current (Driver 2)	1300mA	1400mA	1500mA
Wattage Adjustable	115W	123W	132W

18" Verona

Output Current	1100mA	1200mA	1250mA
Wattage Adjustable	47W	50W	53W

47" Verona

Output Current (Driver 1)	1300mA	1400mA	1500mA
Output Current (Driver 2)	1300mA	1400mA	1500mA
Wattage Adjustable	115W	123W	132W

Attention: 35" and 47" Verona must keep Driver 1 and Driver 2 in same output current when adjust wattage, otherwise will cause damage to the fixtures. Gleaming will not be liable for any damage caused by improper operation.

Verona Round

Surface Mount

14", 18", 24", 35", 47"

Installation Guide



1. Shut off power to the outlet box. (Fig.A)
2. Attached the mounting plate (B) to the outlet box (A), secure with outlet box screws (D). Use the screws holes (H) and wood screws (E) to secure the mounting plate (B) into the ceiling joists.
CAUTIONS: Fixtures must be supported independent of outlet box. Customer is responsible for ensuring appropriate ceiling construction to support the weight of the fixture.
For 24", 35", 47", the wood screws (E) must be extra screwed on the load-bearing material through those screws holes (H).
3. Hang the safety cable couplings (F) to the fixture's safety cable couplings (G).
4. Make appropriate electrical connections using wire nuts.
 - a. Connect the power feed's live wire (black) to the live outlet box wire.
 - b. Connect the power feed's neutral wire (white) to the neutral outlet box wire.
 - c. Connect the fixture's ground wire (green) to the ground outlet box wire. If no ground is present in outlet box, connect fixture's ground wire to the mounting plate using the green screw (By others).
 - d. If not using the 0-10V dimming function, cap off the purple and grey dimming wires.
 - e. Carefully place connections in outlet box.
5. Install the fixture (K) to the mounting plate (B) by inserting the gyros (C) into the key slots (J) on the fixture, then twist to lock the fixture.
6. Restore the power to the fixture.

Care Instructions:

Use a clean, dry cloth when dusting. To protect the finish, avoid any harsh abrasives or chemicals.

Verona Round

Surface Mount

14", 18", 24", 35", 47"

Installation Guide

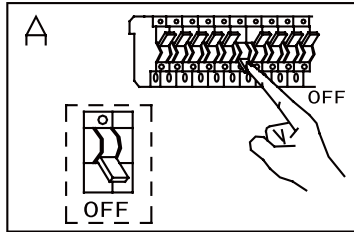

Mount Canopy Body to ceiling

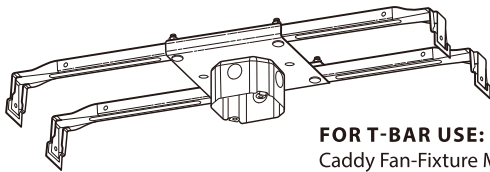

FOR T-BAR USE:
Caddy Fan-Fixture Mount
(BY OTHERS)

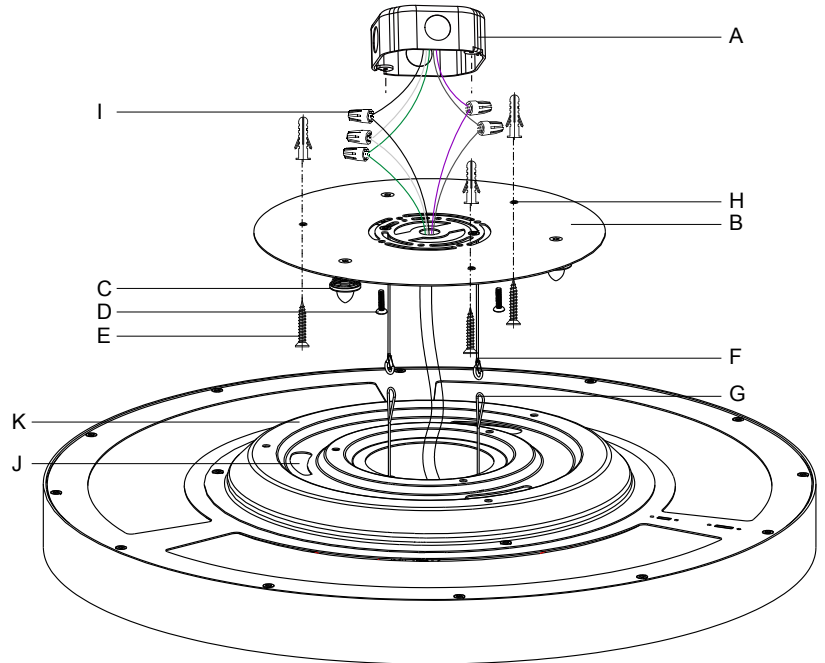

WIRING:

HOT: BLACK
NEUTRAL: WHITE
GROUND: GREEN
CONSTANT OR SECOND CONDUIT HOT(EM): BLUE
0-10V(+): PURPLE
0-10V(-): Grey

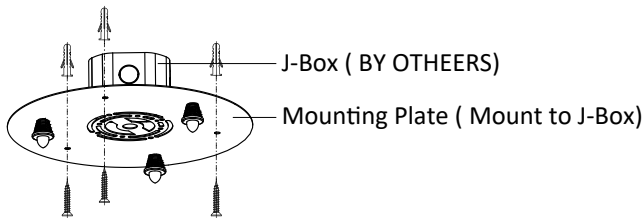

KA4*30mm Screw must be fixed on the mounting plate for 24", 35", 47" fixture.
OPTIONAL: Mount to structural members on fixtures over 50lbs (BY OTHERS)

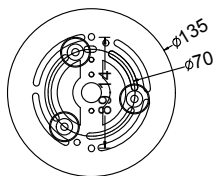

MOUNTING POINT LOCATION
-14" AND 18" VERONA

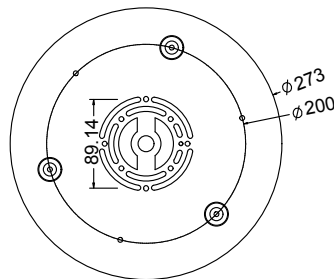

MOUNTING POINT LOCATION
-24" VERONA

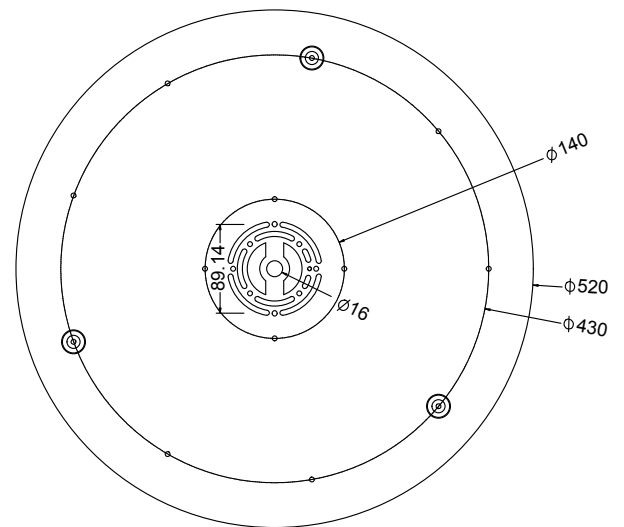

MOUNTING POINT LOCATION
-35" AND 47" VERONA

WARNING: Ground fixture in accordance with local and national electrical codes. Failure to do so may result in serious personal injury.