

LED Linear Pendant

LP28760

INSTALLATION SHEET

START FROM HERE

- Make sure **POWER** is **COMPLETELY OFF** at the fuse box
- Have your fixture installed by a qualified licensed electrician
- Prepare everything in a clear area
- Wear gloves at all times during this installation
- Read instructions carefully before you start assembly
- Keep this installation sheet for future reference

Technical Support: 1-855-855-8926

Please Note:

- This Kuzco LED fixture comes with pre-wired LED module(s)
- Unless instructed, Do Not touch any part of the LED module(s) as any unnecessary contact with the module could cause permanent damage
- For dimming, an ELV (Electronic Low Voltage) or TRIAC type of dimmer is required
- 120V input

1. Remove fixture from its original package
2. Separate mounting plate (1c) from canopy (2a) by removing the canopy screws (2b)
3. Attach mounting plate (1c) to electrical junction box (1a) using junction box screws provided (1e) in hardware package
4. Secure mounting plate (1c) to mounting surface with anchors (1f) and screws (1g)
5. Determine hanging height of fixture by securing rods (2d) to canopy pivot (2c) and fixture body (3a) and attach canopy pivot (2c) to canopy (2a) with washer (5b) and nut (5a), after feeding fixture wires (LED+ and LED-) through rods
6. Make proper electrical connections between LED and DC driver, LED- Negative, LED+ Positive using quick connector provided (See Illustration 1 and refer to diagram on driver)
7. Make proper electrical connections (black to hot "L", white to neutral "N", ground to "GND") with wire nuts (1b) provided in hardware package and place driver (4a) inside canopy (2a)
8. Secure canopy (2a) to mounting plate (1c) with canopy screws (2b)
9. Secure diffuser (3c) to fixture with screws (3b)

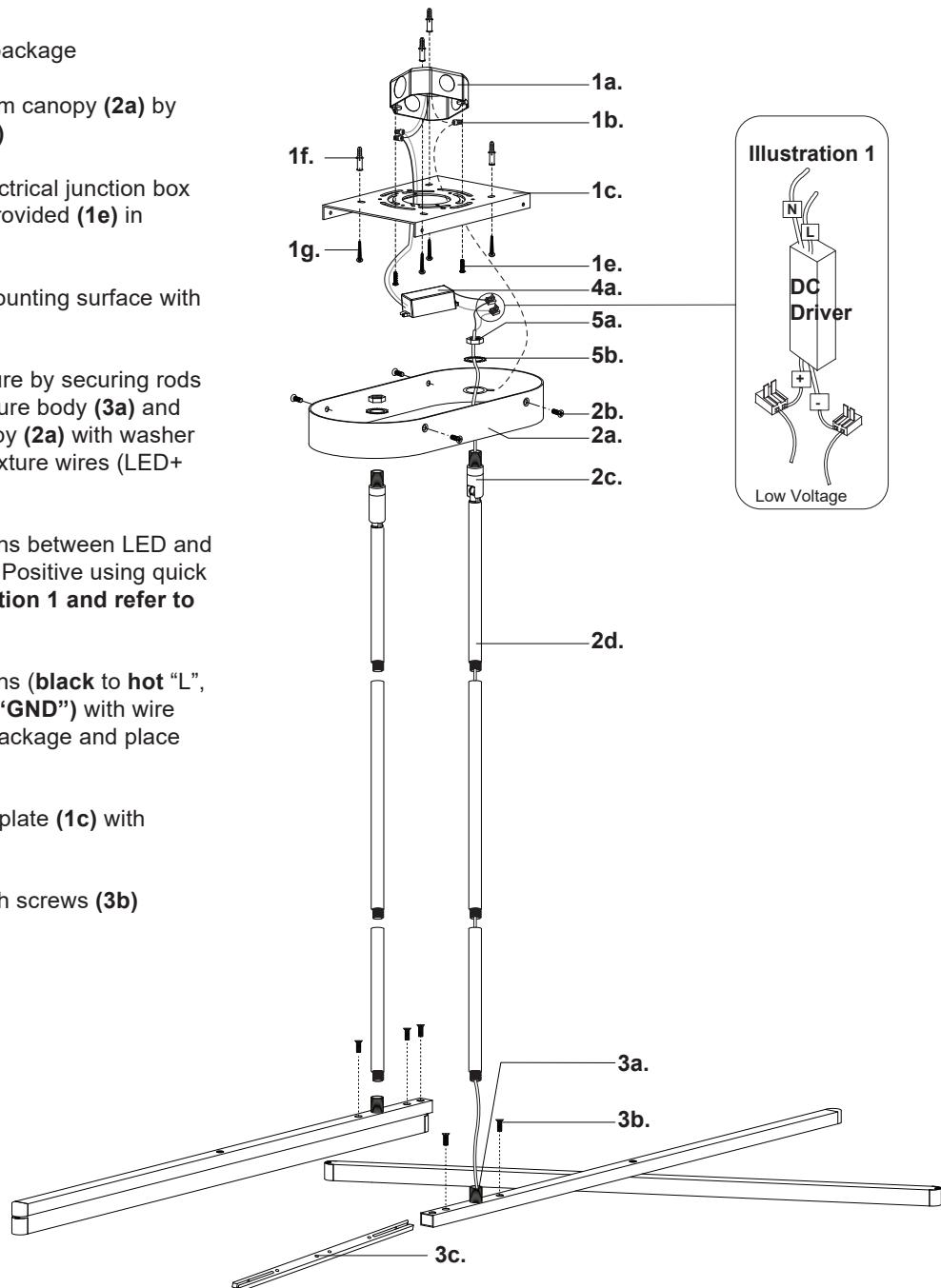

KUZCO

19054 28th Avenue Surrey, BC Canada V3Z 6M3
T: 604 538 7162 TF: 1-855 85 KUZCO F: 604 538 7196
W: kuzcolighting.com
20230109