

INSTALLATION INSTRUCTION

831– LED Pendant

PD-83128

dweLED

CAUTION: To prevent electrical shock, ensure electricity has been turned off at the circuit breaker before beginning.

- Read all instructions before installing.
- System is intended for installation by a licensed electrician in accordance with the National Electrical Code (NEC) and local regulations.
- When handling the fixture, do not apply pressure to the LEDs. Hold the fixture by the base only.
- Retain installation instructions for future maintenance reference.

WARNING: All parts must be used as indicated in these instructions. This product is designed for use only with the supplied parts and/or accessories designated for use by dweLED. Substitution of parts or accessories not designated for use with this product by dweLED could result in personal injury or property damage, and will void the warranty. Contact an authorized dealer or the manufacturer if any parts are damaged or missing.

MAINTENANCE NOTE: Coastal conditions may cause mineral and residue build-up on the fixture. We recommend that customers in coastal areas clean all external surfaces of the fixture once every two weeks with a wet cloth.

MISE EN GARDE: Pour éviter tout choc électrique, assurez-vous que le disjoncteur soit mis hors tension avant de commencer.

- Lisez toutes les instructions avant l'installation.
- Le système doit être installé par un électricien licencié conformément au code national de l'électricité (NEC), et également aux règlements locaux.
- Lors de la manipulation du luminaire, n'appuyez pas sur les LED. Tenez-le uniquement par la base.

ATTENTION: Toutes les pièces doivent être utilisées comme indiqué dans ces instructions. Ce produit est conçu pour être utilisé seulement avec les pièces et/ou accessoires fournis pour être utilisés avec les produits dweLED. Remplacer des pièces ou accessoires non conçus pour ce produit dweLED pourrait causer des dommages corporels ou matériels et pourrait également causer l'annulation de la garantie. Veuillez contacter un revendeur autorisé ou le fabricant si des pièces manquent ou sont endommagées.

NOTE D'ENTRETIEN: Les conditions côtières peut causer une accumulation de minéraux et de résidus sur le luminaire. Nous recommandons aux clients qui résident dans les zones côtières de nettoyer toutes les surfaces externes du luminaire une fois toutes les deux semaines avec un chiffon humide.

HARDWARE

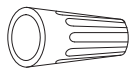

Wire Connector
Qty: 5pcs+1 Extra



Mounting Screw
Qty:1 Extra

dweLED.com
Phone (800) 526.2588
Fax (800) 526.2585

Headquarters/Eastern Distribution Center
44 Harbor Park Drive
Port Washington, NY 11050

Central Distribution Center
1600 Distribution Ct
Lithia Springs, GA 30122

Western Distribution Center
1750 Archibald Avenue
Ontario, CA 91760



INSTALLATION INSTRUCTION

831- LED Pendant

PD-83128

dweLED

PREPARATION

1. Shut off the power at the circuit breaker and remove existing fixture, including the crossbar.
2. Carefully unpack your new fixture and lay out all the parts on a clear area. Be careful not to lose any small parts necessary for installation.

MOUNTING THE FIXTURE (Fig. 1)

3. Loosen the mounting screw (B) from the fixture, and remove the mounting Ring.
4. Secure the mounting Ring to the junction box using standard junction box screws that comes with the junction box.

Note: (i) Using any other non-original-manufacturer provided junction box screw may result in safety issue;
 (ii) The side of the mounting plate marked "GND" must face out.

5. Adjust the fixture wire length by pushing the cable gripper on the canopy and pulling the wire as desired.
 - a) Before securing the canopy in place, it is recommended to retract or extend the wire within the canopy to a desirable length.
 - b) Due to limited space within the canopy, shorten the cable as necessary to make the installation easier. There are labels on the suspending line. Please connect the wires in strict accordance with the labels. Make sure to identify and label all the wiring properly before any trimming/shortening (Fig. 3).

Fig.1

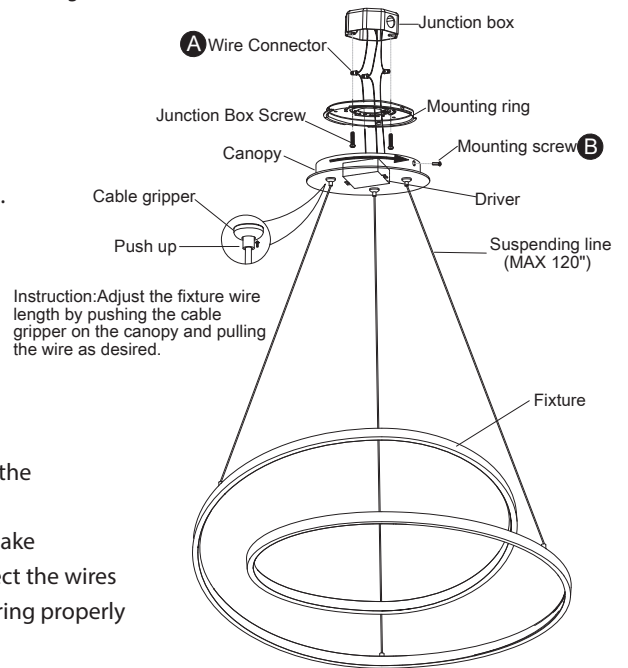

CONNECTING THE WIRES (Fig. 2/ Fig. 3)

6. Connect the driver's output wires to center cable as shown in Fig. 3, red to the center, and black to the bare, make sure that wire connectors (A) are secured. Then tuck them inside the canopy.
7. Connect the driver's input wires to junction box wires as shown in Fig. 2, make sure that all wire connectors (A) are secured. If your outlet box has a green or bare copper ground wire, connect the fixture's ground wire to it. Otherwise, connect the fixture's ground wire directly to the back plate using the screw provided. After wires are connected, tuck them carefully inside the junction box.
8. Secure the fixture by mounting the canopy to the ring of the backplate. Turn and rotate the canopy in the direction of the arrow until it stops. Fasten the canopy to the mounting Ring using the mounting screw (B).

Mounting Ring Dimensions

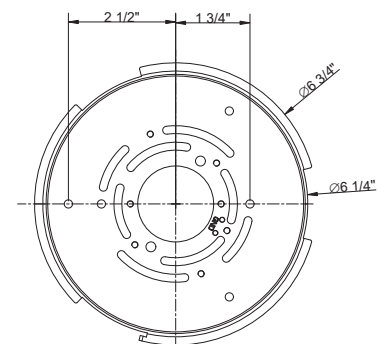

DIMMING WIRING INFORMATION (Fig. 3)

9. This fixture features electronic low voltage (ELV or TRAIC) or 0-10V dimming capabilities. See notes below for specific dimming wires information.
10. To utilize ELV or TRAIC dimming: use wires black (hot), white (neutral) and bare copper ground wire (ground).
11. To utilize 0-10V dimming: use wire purple (dim+), gray (dim-), black (hot), white (neutral) and bare copper ground wire (ground).

Fig.2 Wiring



Fixture Wires	House Wires
Black or Smooth	Black (Hot)
White or Ribbed	White (Neutral)
Bare wire (Ground)	Green or Bare Copper (Ground)

Fig.3 Driver Wires

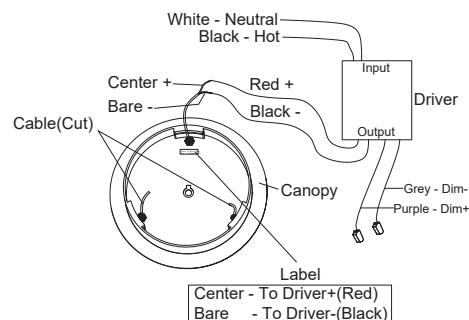

dweLED.com
 Phone (800) 526.2588
 Fax (800) 526.2585

Headquarters/Eastern Distribution Center
 44 Harbor Park Drive
 Port Washington, NY 11050

Central Distribution Center
 1600 Distribution Ct
 Lithia Springs, GA 30122

Western Distribution Center
 1750 Archibald Avenue
 Ontario, CA 91760



INSTALLATION INSTRUCTION

831-LED Pendant

PD-83148

dweLED

CAUTION: To prevent electrical shock, ensure electricity has been turned off at the circuit breaker before beginning.

- Read all instructions before installing.
- System is intended for installation by a licensed electrician in accordance with the National Electrical Code (NEC) and local regulations.
- When handling the fixture, do not apply pressure to the LEDs. Hold the fixture by the base only.
- Retain installation instructions for future maintenance reference.

WARNING: All parts must be used as indicated in these instructions. This product is designed for use only with the supplied parts and/or accessories designated for use by dweLED. Substitution of parts or accessories not designated for use with this product by dweLED could result in personal injury or property damage, and will void the warranty. Contact an authorized dealer or the manufacturer if any parts are damaged or missing.

MAINTENANCE NOTE: Coastal conditions may cause mineral and residue build-up on the fixture. We recommend that customers in coastal areas clean all external surfaces of the fixture once every two weeks with a wet cloth.

MISE EN GARDE: Pour éviter tout choc électrique, assurez-vous que le disjoncteur soit mis hors tension avant de commencer.

- Lisez toutes les instructions avant l'installation.
- Le système doit être installé par un électricien licencié conformément au code national de l'électricité (NEC), et également aux règlements locaux.
- Lors de la manipulation du luminaire, n'appuyez pas sur les LED. Tenez-le uniquement par la base.

ATTENTION: Toutes les pièces doivent être utilisées comme indiqué dans ces instructions. Ce produit est conçu pour être utilisé seulement avec les pièces et/ou accessoires fournis pour être utilisés avec les produits dweLED. Remplacer des pièces ou accessoires non conçus pour ce produit dweLED pourrait causer des dommages corporels ou matériels et pourrait également causer l'annulation de la garantie. Veuillez contacter un revendeur autorisé ou le fabricant si des pièces manquent ou sont endommagées.

NOTE D'ENTRETIEN: Les conditions côtières peut causer une accumulation de minéraux et de résidus sur le luminaire. Nous recommandons aux clients qui résident dans les zones côtières de nettoyer toutes les surfaces externes du luminaire une fois toutes les deux semaines avec un chiffon humide.

HARDWARE



Wire Connector
Qty: 5pcs+1 Extra



Back Plate Screw
Qty: 1 Extra

dweLED.com
Phone (800) 526.2588
Fax (800) 526.2585

Headquarters/Eastern Distribution Center
44 Harbor Park Drive
Port Washington, NY 11050

Central Distribution Center
1600 Distribution Ct
Lithia Springs, GA 30122

Western Distribution Center
1750 Archibald Avenue
Ontario, CA 91760



INSTALLATION INSTRUCTION

831-LED Pendant

PD-83148

dweLED

Fig.1

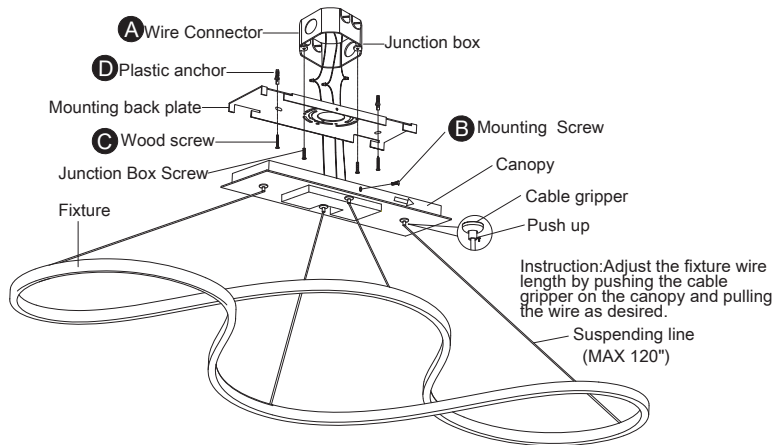
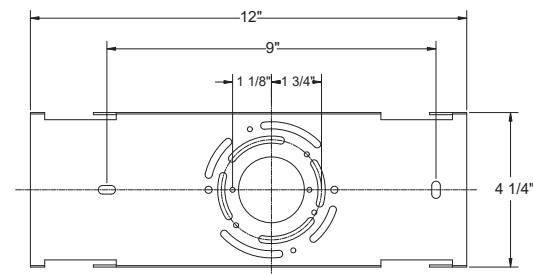

Fig.2 Wiring



Fixture Wires	House Wires
Black or Smooth	Black (Hot)
White or Ribbed	White (Neutral)
Bare wire (Ground)	Green or Bare Copper (Ground)

Mounting Backplate Dimensions



PREPARATION

1. Shut off the power at the circuit breaker and remove existing fixture, including the crossbar.
2. Carefully unpack your new fixture and lay out all the parts on a clear area. Be careful not to lose any small parts necessary for installation.

MOUNTING THE FIXTURE (Fig. 1)

3. Loosen the mounting screw (B) from the fixture, and remove the mounting back plate.
4. Secure the mounting back plate to the junction box using standard junction box screws that comes with the junction box.

Note: (i) Using any other non-original-manufacturer provided junction box screw may result in safety issue;

(ii) The side of the mounting plate marked "GND" must face out.

5. Adjust the fixture wire length by pushing the cable gripper on the canopy and pulling the wire as desired.
 - a) Before securing the canopy in place, it is recommended to retract or extend the wire within the canopy to a desirable length.
 - b) Due to limited space within the canopy, shorten the cable as necessary to make the installation easier. Please connect the wires in strict accordance with the labels. Make sure to identify and label all the wiring properly before any trimming/shortening (Fig. 3).

CONNECTING THE WIRES (Fig. 2 / Fig. 3)

6. Connect the driver's output wires to center cable as shown in Fig. 3, red to the center, and black to the bare, make sure that wire connectors (A) are secured. Then tuck them inside the canopy.
7. Connect the driver's input wires to junction box wires as shown in Fig. 2, make sure that all wire connectors (A) are secured. If your outlet box has a green or bare copper ground wire, connect the fixture's ground wire to it. Otherwise, connect the fixture's ground wire directly to the back plate using the screw provided. After wires are connected, tuck them carefully inside the junction box.
8. Secure the fixture by mounting the canopy to the mounting back plate. Turn and move the canopy in the direction of the arrow until it stops.

DIMMING WIRING INFORMATION (Fig. 3)

9. This fixture features electronic low voltage (ELV or TRAIC) or 0-10V dimming capabilities. See notes below for specific dimming wires information.
10. To utilize ELV or TRAIC dimming: use black (hot), white (neutral) and bare copper ground wires (ground).
11. To utilize 0-10V dimming: use purple (dim+), gray (dim-), black (hot), white (neutral) and bare copper ground wires (ground).

NOTE: Make sure to connect 0-10V prior to power-up the fixture in order to allow the 0-10V dimming to function properly.

COMPLETING THE INSTALLATION

Fig.3 Driver Wires

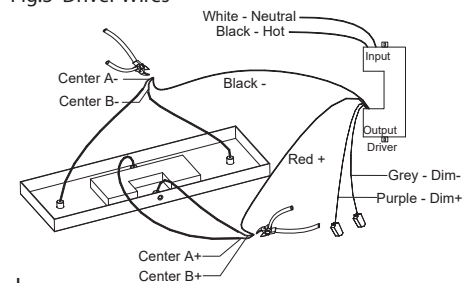

dweLED.com
Phone (800) 526.2588
Fax (800) 526.2585

Headquarters/Eastern Distribution Center
44 Harbor Park Drive
Port Washington, NY 11050

Central Distribution Center
1600 Distribution Ct
Lithia Springs, GA 30122

Western Distribution Center
1750 Archibald Avenue
Ontario, CA 91760

