

# INSTALLATION INSTRUCTIONS

## 392-LED Pendant

### PD-39214

# dweLED

**CAUTION: To prevent electrical shock, ensure electricity has been turned off at the circuit breaker before beginning.**

- Read all instructions before installing.
- System is intended for installation by a licensed electrician in accordance with the National Electrical Code (NEC) and local regulations.
- When handling the fixture, do not apply pressure to the LEDs. Hold the fixture by the base only.
- Retain installation instructions for future maintenance reference.

**WARNING:** All parts must be used as indicated in these instructions. This product is designed for use only with the supplied parts and/or accessories designated for use by Modern Forms. Substitution of parts or accessories not designated for use with this product by Modern Forms could result in personal injury or property damage, and will void the warranty. Contact an authorized dealer or the manufacturer if any parts are damaged or missing.

**MAINTENANCE NOTE:** Coastal conditions may cause mineral and residue build-up on the fixture. We recommend that customers in coastal areas clean all external surfaces of the fixture once every two weeks with a wet cloth.

**MISE EN GARDE:** Pour éviter tout choc électrique, assurez-vous que le disjoncteur soit mis hors tension avant de commencer.

- Lisez toutes les instructions avant l'installation.
- Le système doit être installé par un électricien licencié conformément au code national de l'électricité (NEC), et également aux règlements locaux.
- Lors de la manipulation du luminaire, n'appuyez pas sur les LED. Tenez-le uniquement par la base.

**ATTENTION:** Toutes les pièces doivent être utilisées comme indiqué dans ces instructions. Ce produit est conçu pour être utilisé seulement avec les pièces et/ou accessoires fournis pour être utilisés avec les produits Modern Forms. Remplacer des pièces ou accessoires non conçus pour ce produit Modern Forms pourrait causer des dommages corporels ou matériels et pourrait également causer l'annulation de la garantie. Veuillez contacter un revendeur autorisé ou le fabricant si des pièces manquent ou sont endommagées.

**NOTE D'ENTRETIEN:** Les conditions côtières peut causer une accumulation de minéraux et de résidus sur le luminaire. Nous recommandons aux clients qui résident dans les zones côtières de nettoyer toutes les surfaces externes du luminaire une fois toutes les deux semaines avec un chiffon humide.

## HARDWARE

A

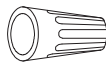

Wire Connector  
Qty: 3pcs+1Extra

B



Mounting Screw  
Qty: 1 Extra

C



Wire Connector  
Qty: 2pcs+1Extra

dweLED.com  
Phone (800) 526.2588  
Fax (800) 526.2585

Headquarters/Eastern Distribution Center  
44 Harbor Park Drive  
Port Washington, NY 11050

Central Distribution Center  
1600 Distribution Ct  
Lithia Springs, GA 30122

Western Distribution Center  
1750 Archibald Avenue  
Ontario, CA 91760



# INSTALLATION INSTRUCTIONS

## 392-LED Pendant

### PD-39214

# dweLED

#### PREPARATION

1. Shut off the power at the circuit breaker and remove existing fixture, including the crossbar.
2. Carefully unpack your new fixture and lay out all the parts on a clear area. Be careful not to lose any small parts necessary for installation.

#### MOUNTING THE FIXTURE (Fig. 1/Fig.3)

3. Loosen the mounting screw (B) from the fixture, and remove the mounting plate.
4. Secure the mounting back plate to the junction box using standard junction box screws that comes with the junction box.

Note: (i) using any other non-original-manufacturer provided junction box screw may result in safety issue;

(ii) The side of the mounting plate marked "GND" must face out.

5. Adjust the fixture wire length by pushing the cable gripper on the canopy and pulling the wire as desired.
  - a) Before securing the canopy in place, it is recommended to retract or extend the wire within the canopy to a desirable length.
  - b) Due to limited space within the canopy, shorten the cable as necessary to make the installation easier. Make sure to identify and label all the wiring properly before any trimming/shortening (Fig. 3).

#### CONNECTING THE WIRES (Fig. 2/Fig.3)

6. Connect the driver's output wires to center cable as shown in Fig. 3, red to the center, and black to the bare, make sure that wire connectors (C) are secured. Then tuck them inside the canopy.
7. Connect the driver's input wires to junction box wires as shown in Fig. 2, make sure that all wire connectors (A) are secured. If your outlet box has a green or bare copper ground wire, connect the fixture's ground wire to it. Otherwise, connect the fixture's ground wire directly to the mounting plate using the screw provided. After wires are connected, tuck them carefully inside the junction box.

#### COMPLETING THE INSTALLATION

8. Secure the fixture by mounting the canopy to the ring of the mounting plate. Turn and rotate the canopy in the direction of the arrow until it stops. Fasten the canopy to the mounting plate using the mounting screw (B).

Fig.1

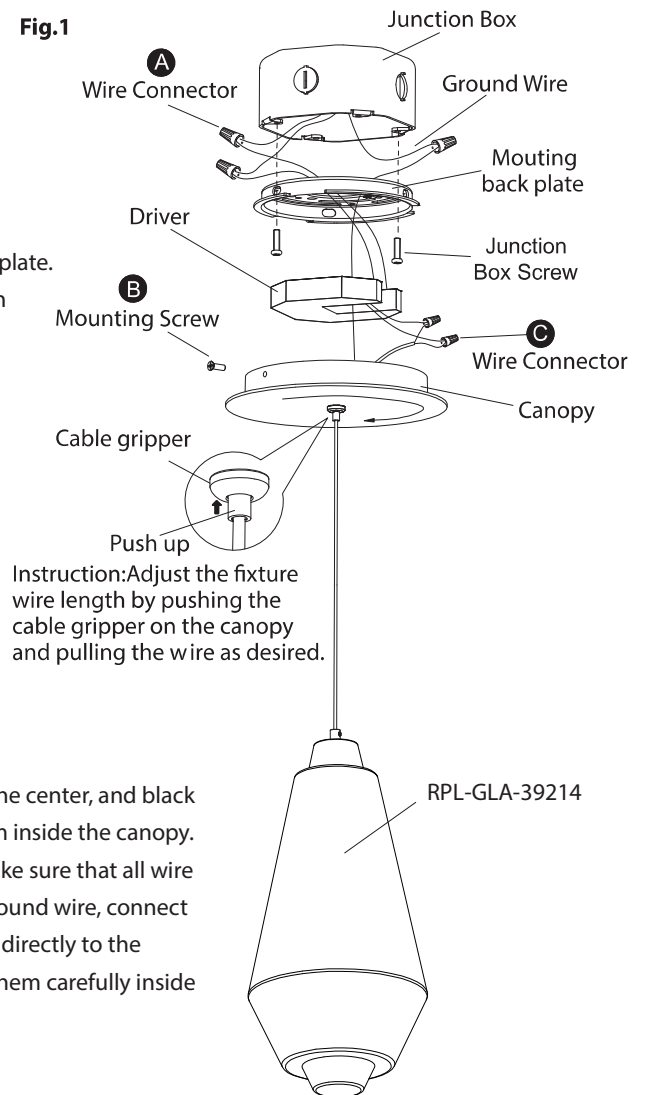

Instruction: Adjust the fixture wire length by pushing the cable gripper on the canopy and pulling the wire as desired.

Fig.2 Wiring



	<b>Fixture Wires</b> Black or Smooth	<b>House Wires</b> Black (Hot)
	<b>Fixture Wires</b> White or Ribbed	<b>House Wires</b> White (Neutral)
	<b>Fixture Wires</b> Bare wire (Ground)	<b>House Wires</b> Green or Bare Copper (Ground)

Fig.3 Driver Wiring



PD-30206  
Back Plate Dimensions

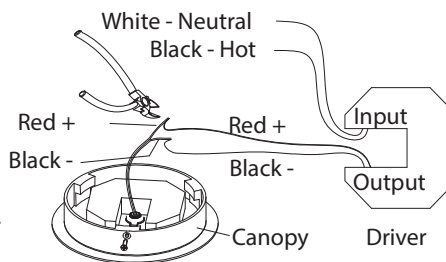
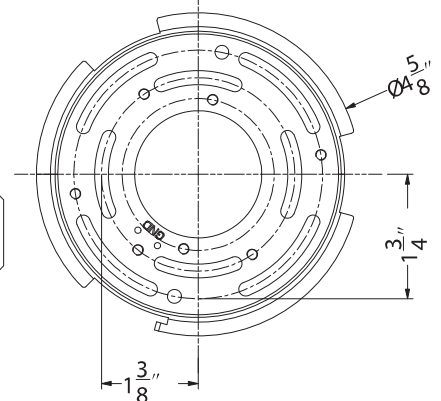

dweLED.com  
Phone (800) 526.2588  
Fax (800) 526.2585

Headquarters/Eastern Distribution Center  
44 Harbor Park Drive  
Port Washington, NY 11050

Central Distribution Center  
1600 Distribution Ct  
Lithia Springs, GA 30122

Western Distribution Center  
1750 Archibald Avenue  
Ontario, CA 91760

