

INSTALLATION INSTRUCTIONS
643-Outdoor Wall Sconce
 WS-W64322/WS-W64316

MODERN FORMS

CAUTION: To prevent electrical shock, ensure electricity has been turned off at the circuit breaker before beginning.

- Read all instructions before installing.
- System is intended for installation by a licensed electrician in accordance with the National Electrical Code (NEC) and local regulations.
- When handling the fixture, do not apply pressure to the LEDs. Hold the fixture by the base only.
- Retain installation instructions for future maintenance reference.

WARNING: All parts must be used as indicated in these instructions. This product is designed for use only with the supplied parts and/or accessories designated for use by Modern Forms. Substitution of parts or accessories not designated for use with this product by Modern Forms could result in personal injury or property damage, and will void the warranty. Contact an authorized dealer or the manufacturer if any parts are damaged or missing.

MAINTENANCE NOTE: Coastal conditions may cause mineral and residue build-up on the fixture. We recommend that customers in coastal areas clean all external surfaces of the fixture once every two weeks with a wet cloth.











MISE EN GARDE: Pour éviter tout choc électrique, assurez-vous que le disjoncteur soit mis hors tension avant de commencer.

- Lisez toutes les instructions avant l'installation.
- Le système doit être installé par un électricien licencié conformément au code national de l'électricité (NEC), et également aux règlements locaux.
- Lors de la manipulation du luminaire, n'appuyez pas sur les LED. Tenez-le uniquement par la base.

ATTENTION: Toutes les pièces doivent être utilisées comme indiqué dans ces instructions. Ce produit est conçu pour être utilisé seulement avec les pièces et/ou accessoires fournis pour être utilisés avec les produits Modern Forms. Remplacer des pièces ou accessoires non conçus pour ce produit Modern Forms pourrait causer des dommages corporels ou matériels et pourrait également causer l'annulation de la garantie. Veuillez contacter un revendeur autorisé ou le fabricant si des pièces manquent ou sont endommagées.

NOTE D'ENTRETIEN: Les conditions côtières peut causer une accumulation de minéraux et de résidus sur le luminaire. Nous recommandons aux clients qui résident dans les zones côtières de nettoyer toutes les surfaces externes du luminaire une fois toutes les deux semaines avec un chiffon humide.

HARDWARE

 <p>A</p>	 <p>B</p>	 <p>C</p>	 <p>D</p>	 <p>E</p>
<p>Wire Connector Qty: 3PCS+1 Extra</p>	<p>Mounting Screw Qty: 1 Extra</p>	<p>Rubber Gasket Qty: 1 Extra</p>	<p>Plastic Anchor Qty: 2PCS+1 Extra</p>	<p>Anchor Screw Qty: 2PCS+1 Extra</p>
 <p>F</p>	 <p>G</p>	 <p>H</p>	 <p>I</p>	 <p>J</p>
<p>Flat-head Screw Qty: 1 Extra</p>	<p>Decorative Plate Screw Qty: 1 Extra</p>	<p>Round Screw Qty: 1PC+1 Extra</p>	<p>Washer Qty: 1PC+1 Extra</p>	<p>Silicone Gasket Qty: 1PC+1 Extra</p>

modernforms.com
 Phone (800) 526.2588
 Fax (800) 526.2585

Headquarters/Eastern Distribution Center
 44 Harbor Park Drive
 Port Washington, NY 11050

Central Distribution Center
 1600 Distribution Ct
 Lithia Springs, GA 30122

Western Distribution Center
 1750 Archibald Avenue
 Ontario, CA 91760



INSTALLATION INSTRUCTIONS
643-Outdoor Wall Sconce
 WS-W64322/WS-W64316

MODERN FORMS

PREPARATION

1. Shut off the power at the circuit breaker and remove existing fixture, including the crossbar.
2. Carefully unpack your new fixture and lay out all the parts on a clear area. Be careful not to lose any small parts necessary for installation.

MOUNTING THE FIXTURE (Fig. 1)

3. Remove the mounting screw (B) and rubber gasket(C) from the fixture,take down the mounting plate.
4. Drill holes in the wall with the key holes located in the mounting plate. Insert the plastic anchors (D).
5. Put the cloudy glass into the lamp and tighten with flat head screws(F),round screw(H),washer(I),silicone gasket(J).
 WS-W64322 4pcs flat head screws(F),
 WS-W64316 3pcs flat head screws(F).
6. Place the decorative plate on the fixture and then tighten it with screws(G).
7. Secure the mounting plate to the junction box using the junction box screws.Fasten the mounting plate to the wall with the plastic anchors (D) using the anchor screws (E) provided. Hook the safety cord to the mounting plate(only WS-W64322).

Note: (i) using any other non-original-manufacturer provided junction box screw may result in safety issue;
 (ii) The side of the mounting back plate marked "GND" must face out.

CONNECTING THE WIRES (Fig. 2)

8. Connect the fixture's wires to the junction box wires as shown in Fig. 2 using wire connectors (A) provided. Ensure wire connectors are secure. Connect the fixture's ground wire to the ground in the junction box; this will be either a green wire or a bare copper wire. After fixture is wired to house wires, tuck wires carefully inside the junction box.

COMPLETING THE INSTALLATION

9. Secure the fixture to the mouting plate use the mounting screw (B) and rubber gasket(C).
10. To prevent moisture from entering the outlet box and causing a short, use clear caulking(i.e. indoor/outdoor silicone sealant) to outline the outside of fixture back plate where it meets the wall. Leave a space at the bottom to allow the moisture to escape (Fig. 3).

Fig.4 Mounting Plate Dimensions

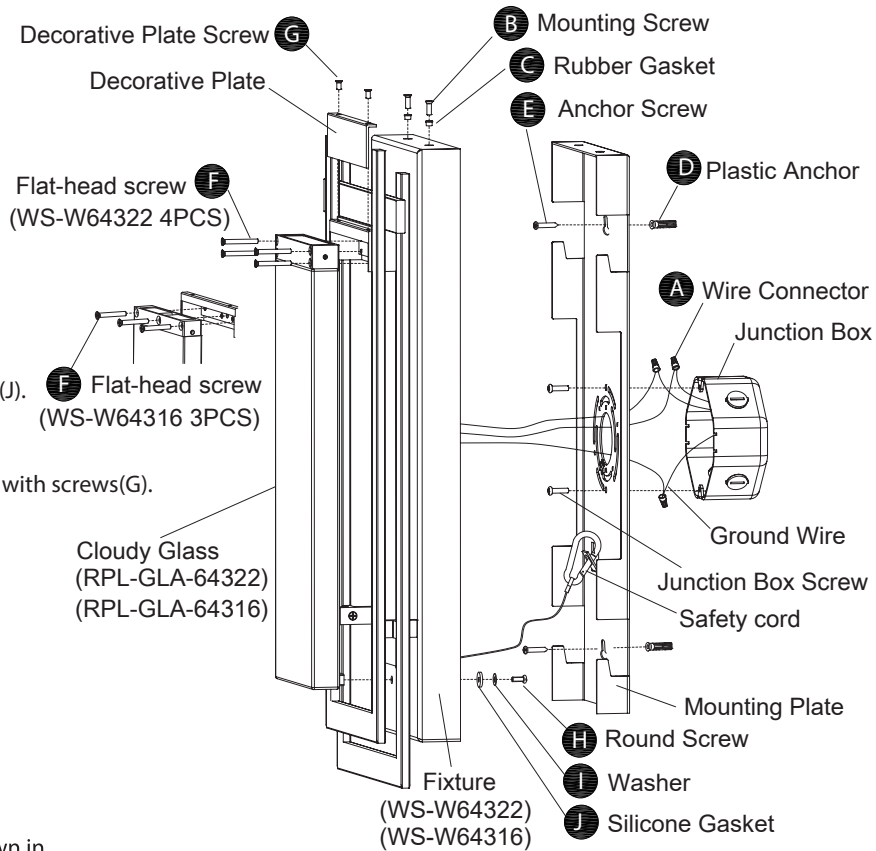
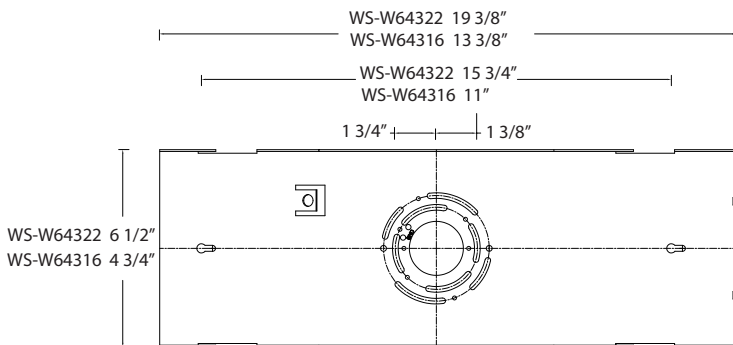

Fig.2 Wiring

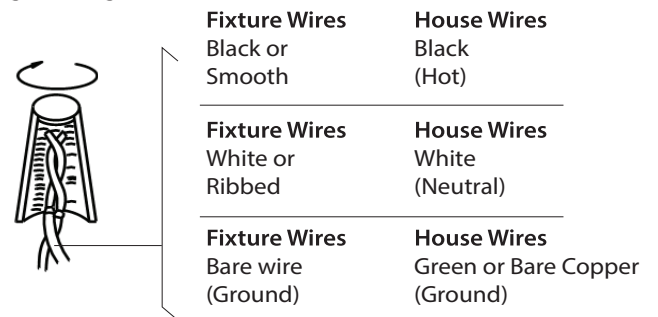
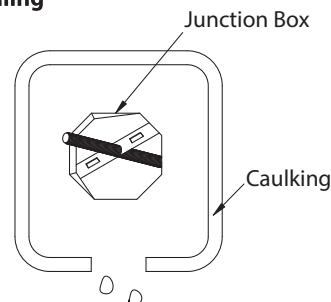

Fig.3 Sealing



modernforms.com
 Phone (800) 526.2588
 Fax (800) 526.2585

Headquarters/Eastern Distribution Center
 44 Harbor Park Drive
 Port Washington, NY 11050

Central Distribution Center
 1600 Distribution Ct
 Lithia Springs, GA 30122

Western Distribution Center
 1750 Archibald Avenue
 Ontario, CA 91760

