

**WARNING**

**IMPORTANT: NEVER attempt any work without shutting off the electricity.**

- Read all instructions before installing.
- System is intended to be installed by a qualified electrician in accordance with the National Electrical Code and local regulations.
- Place the main power switch in the "OFF" position and remove the fuse(s) or switch "OFF" the circuit breakers which control the power to the fixture or room that you are working on.
- Place the wall switch in the "OFF" position.

**CAUTION**

- All parts must be used as indicated in these instructions. Do not substitute any parts, leave parts out, or use any parts that are worn out or broken. Failure to follow this instruction could invalidate the ETL/CETL listing of this fixture.

**CAUTION** When handling the fixture, do not apply pressure to the LEDs. Hold the fixture by the base only.

**AVERTISSEMENT**

**IMPORTANT : Coupez l'électricité avant TOUTE manipulation.**

- Lisez toutes les instructions avant d'installer.
- Système est destiné à être installé par un électricien qualifié en conformité avec le code national de l'électricité et les règlements locaux.
- Accédez au panneau central de disjoncteurs ou de fusibles de votre demeure et placez l'interrupteur principal en position d'arrêt (« OFF »).
- Placez l'interrupteur mural en position d'arrêt (« OFF »).

**MISE EN GARDE**

- Toutes les pièces doivent être utilisées tel qu'il est indiqué dans ces instructions. Ne remplacez pas les pièces, n'en laissez pas de côté et ne les utilisez pas si elles sont usées ou brisées. Le non-respect de ces instructions peut annuler l'homologation ETL/CETL du luminaire.

**MISE EN GARDE**

Ors de la manipulation de l'appareil, ne pas appliquer de pression à la LED, tenir l'appareil par la seule base.

**ADVERTENCIA**

**IMPORTANTE: NUNCA intente hacer trabajos sin desconectar el suministro eléctrico.**





- Lea y comprenda todas las instrucciones e ilustraciones por completo antes de proceder con el ensamblaje e instalación de esta lámpara.
- Sistema está diseñado para ser instalado por un electricista calificado, de acuerdo con el código eléctrico nacional y las normas locales.
- Diríjase a la caja de fusibles o a la caja del interruptor de circuito principal en su hogar. Coloque el interruptor de alimentación principal en la posición "OFF" (APAGADO).
- Coloque el interruptor de la pared en la posición "OFF" (APAGADO).

**PRECAUCIÓN**

- Todas las piezas deben usarse como lo indican estas instrucciones. No reemplace las piezas, no omita piezas durante la instalación ni utilice piezas gastadas o rotas. El incumplimiento de esta indicación podría invalidar la calificación ETL/CETL esta lámpara.

**PRECAUCIÓN** Al manipular el aparato, no aplique presión a los LED, mantenga el aparato en la base sólo.

**Hardware**

<b>A</b>	<b>B</b>	<b>C</b>	<b>D</b>	<b>E</b>
				
Wire Connector Qty: 3pcs+1Extra 7EAC112201 P3	Junction Box Screw Qty: 2pcs+1 extra 7MPF0415C2 #8-32x5/8 SS	Mounting Screw Qty:1 extra 7MPF0412S1 (AL) 7MPF0412S1BK (BK) 4MPF0412S2BB1 (AB) 5/32-32x1/2	Plastic Anchor Qty: 2pcs+1 extra 7TDD082401	Wood Screw Qty: 2pcs+1 extra 7MPF2204J2

INSTALLATION INSTRUCTION  
**208-LED Pendant**  
 PD-64872



Fig. 1

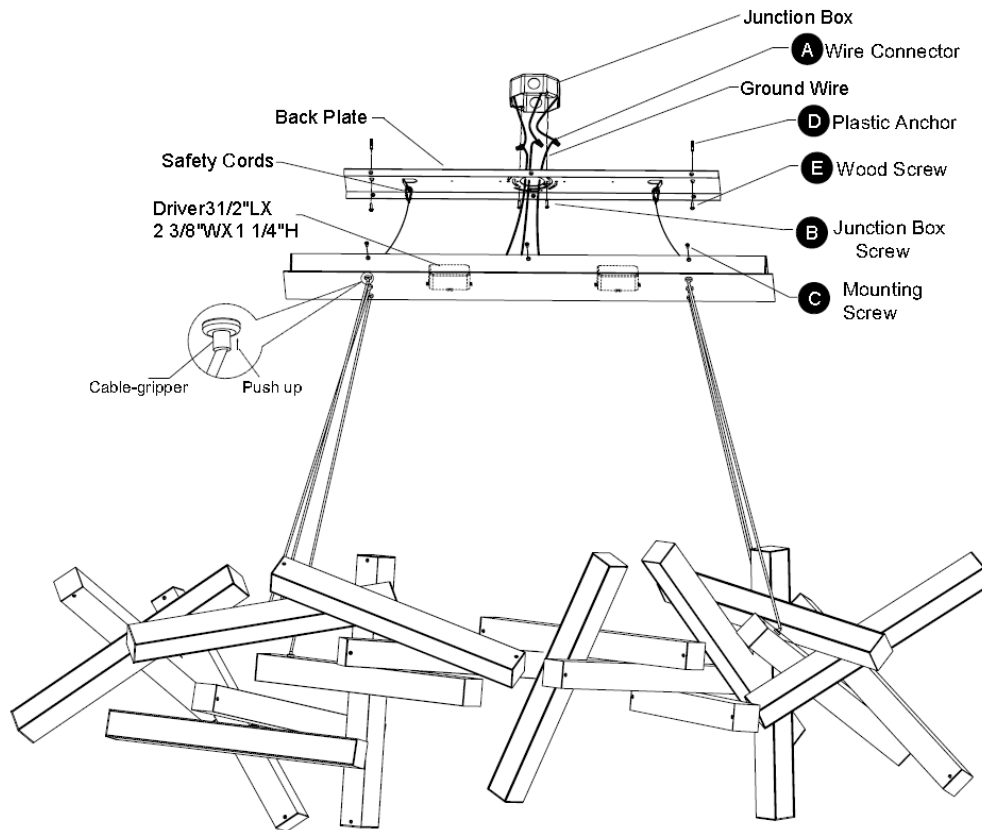

**PREPARATION**

1. Shut off the power at the circuit breaker and remove existing fixture, including the crossbar.
2. Carefully unpack your new fixture and lay out all the parts on a clear area. Be careful not to lose any small parts necessary for installation.

**MOUNTING THE FIXTURE** (Fig. 1)

3. Remove the mounting screw (C) from the fixture.
4. Drill holes in the wall aligned with the key holes located in the mounting back plate, insert the plastic anchor (D).
5. Secure back plate to the junction box using junction box screws (B), fasten it to the wall using wood screw (E). The side of the mounting plate marked "GND" must face out.
6. Adjust the fixture wire length by pushing the cable gripper on the canopy and pulling the wire as desired.

**CONNECTING THE WIRES** (Fig. 2)

7. Connect the driver input wires with junction box wires as shown in Fig.2, making sure that all wire connectors (A) are secured. If your outlet box has a green or bare copper ground wire, connect the fixture's ground wire to it. Otherwise, connect the fixture's ground wire directly to the mounting plate using the green screw provided. After wires are connected, tuck them carefully inside the junction box.
8. Hook the two safety cords to the back plate.
9. Place the fixture over the back plate and secure it with mounting screws (C).

Fig.2 Wiring

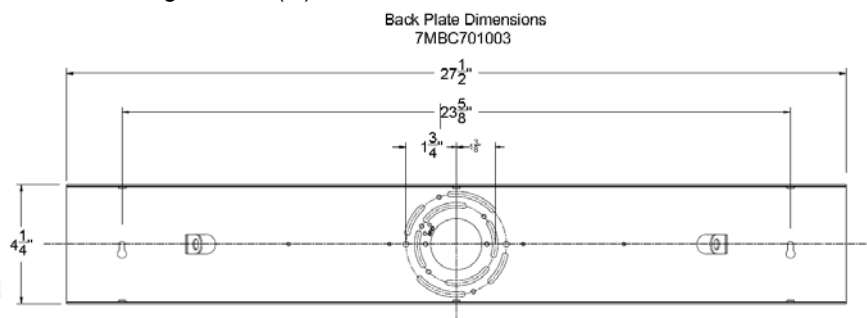
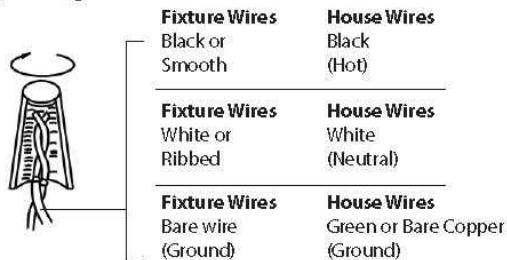

Modern Forms  
[www.modernforms.com](http://www.modernforms.com)  
 Phone (800) 526.2588 • Fax (800) 526.2585

Headquarters/Eastern Distribution Center  
 44 Harbor Park Drive • Port Washington, NY 11050  
 Phone (516) 515.5000 • Fax (516) 515.5050

Western Distribution Center  
 1750 Archibald Ave • Ontario, CA 91761  
 Phone (800) 526.2588 • Fax (800) 526.2585

