

QUESTIONS OR CONCERNS CONTACT CANARM AT:

1-800-265-1833 (English) / 1-800-567-2513 (French) Monday through Friday 8:00 AM to 5:00 PM E.S.T.



"INSTRUCTIONS PERTAINING TO RISK OF FIRE OR INJURY TO PERSONS"
"READ ALL INSTRUCTIONS"

"IMPORTANT SAFETY INSTRUCTIONS"

"SAVE THESE INSTRUCTIONS"

TOOLS AND MATERIALS REQUIRED:



Phillips Screwdriver



Wire Cutters

Wiring supplies as required by the Canadian Electrical Code and/or the Quebec Electrical code

SAFETY PRECAUTIONS:

1. TURN OFF ELECTRICAL POWER BEFORE STARTING INSTALLATION OF LIGHT FIXTURE.
2. THIS PRODUCT MUST BE INSTALLED IN ACCORDANCE WITH THE APPLICABLE INSTALLATION CODE BY A PERSON FAMILIAR WITH THE CONSTRUCTION AND OPERATION OF THE PRODUCT AND THE HAZARDS INVOLVED.
3. CONNECT THE GROUND WIRES (BARE COPPER OR GREEN) FROM YOUR FIXTURE TO THE GROUND WIRE (BARE COPPER OR GREEN) OR GROUND SCREW IN THE ELECTRICAL OUTLET BOX.
4. CLEAN GLASS WITH WATER ONLY.

NOTE: Product May Not Look Exactly As Shown In Figures.

INSTALLATION:

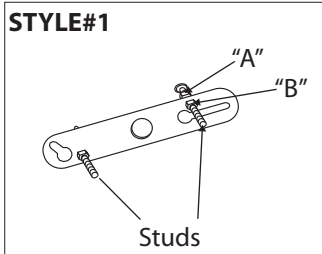

1. **Note:** Refer to the mounting bracket style that matches the bracket that is included with your fixture.

Style#1 (Non-Threaded holes)
Loosen hex nut "A" and "B". Adjust stud so it clears the fixture once assembled. Hold in place with "A" and lock in place with "B".

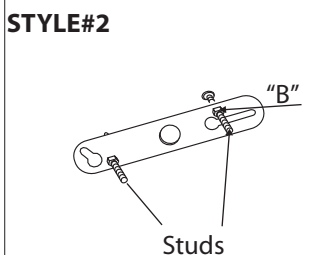

Style#2 (Threaded holes)
Loosen "B". Adjust stud to desired length and lock in place with "B".

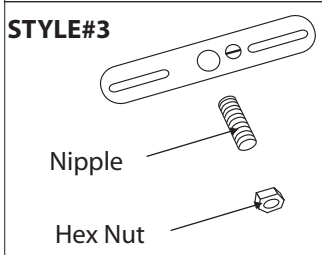

Style#3 (Nipple)
Attach nipple to mounting bracket and adjust until it will clear fixture when assembled. Lock in place using the hex nut.

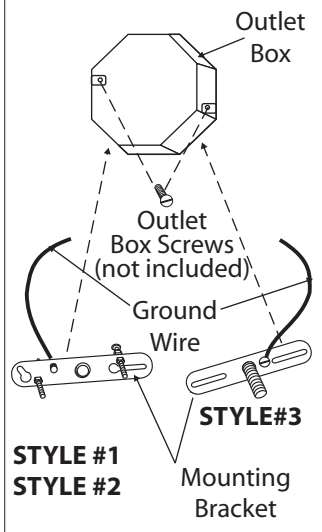

2. Mount the mounting bracket to outlet box using outlet box screws (not included). Make sure the studs or nipple on the mounting bracket are facing out from the outlet box.

3. Connect the ground wires (bare copper or green) from your fixture to the ground wire (bare copper or green) or ground screw in the electrical outlet box. Connect black wire from fixture to black wire in outlet box and connect the white wire from fixture to white wire in outlet box.

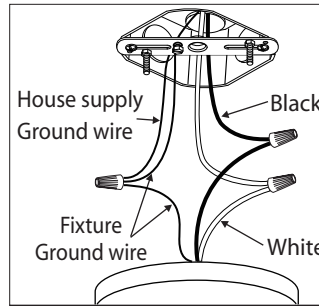

4. Once connections of wires are completed, carefully tuck wires and wire nuts into the outlet box making sure no bare wire (on the black and white) is visible at the wire nuts. Install the light fixture to the wall by aligning the hole(s) in the fixture with the studs or nipple on the mounting bracket. Secure in place with cap nut(s) and star washer(s).

Note: If required, assemble body and spread the arms of the fixture out evenly.

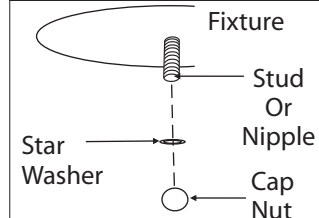

5. **Note:** Refer to the style of assembly that matches the style of your fixture.

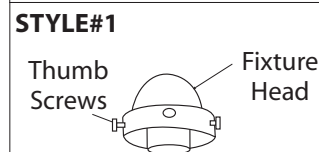

Style#1 - Place the decorative ring over the glass shade. Attach the glass shade to the fixture socket using the thumb screws (tighten with fingers only). Install proper bulb type and wattage (not included).

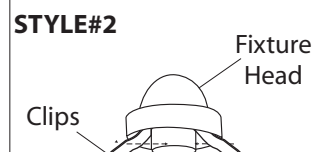

Style#2 - Squeeze the clips together around the socket. Slide the glass over the clips, then push the glass up snug to the fixture head.

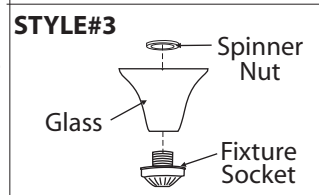

Style#3 - Remove spinner nut from socket. Position glass on the fixture and secure with spinner nut.

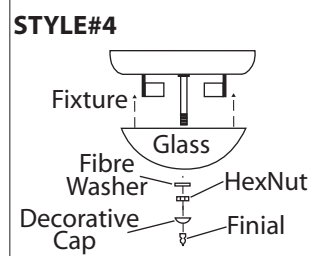

Style#4 - Secure the glass in place using the fibre washer, hex nut, decorative cap and finial.