

GAMA SONIC[®]

SOLAR LIGHTING

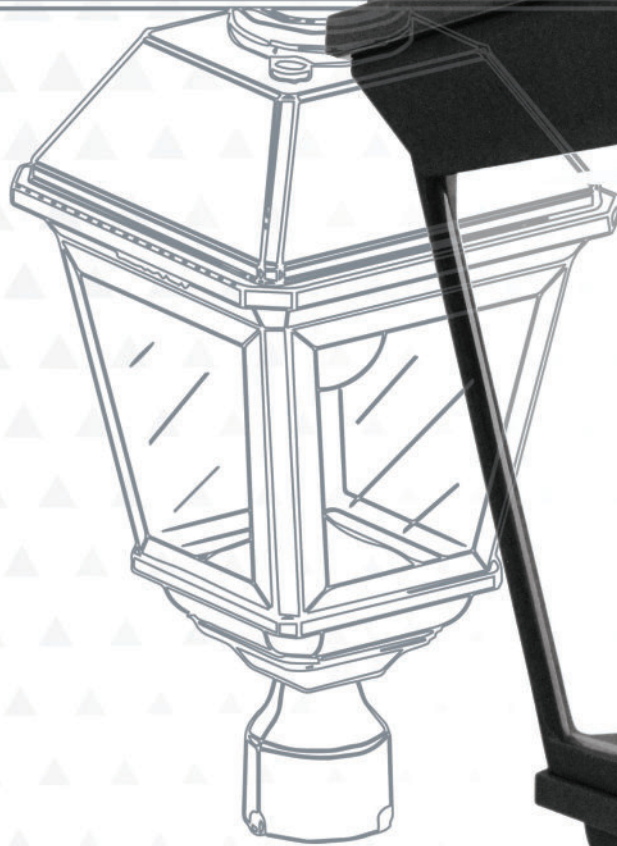
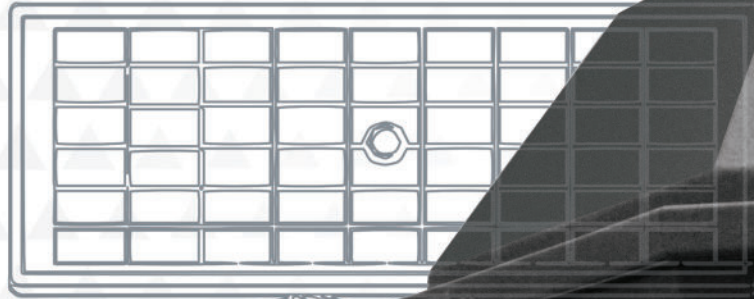

Instruction Manual

IMPERIAL SOLAR LAMP - AUTOMATIC TRACKING SYSTEM Model: GS-97ATS

US Patent # 7172307 / 9458970

Version 1.1

 Please read the instruction manual carefully to obtain the best results from your purchase.

Thank you for your purchase. GAMA SONIC® solar charged lighting eliminates the problems associated with most solar lighting available today. GAMA SONIC® solar charged lights are brighter and last all night with a full day solar charge. Unique designs, superior light output, and numerous installation options confirm the outstanding value of our product.

For technical assistance and more information call our Toll-Free number:
800-835-4113 (only within the US)

Or

visit our website or download the latest version of your instruction manual:
www.gamasonic.com Or **www.gamasonic.com/user-guides**

Solar Lamp Pre-Installation Guidelines

1. For optimal light duration throughout the night, it is very important to mount your solar light in a spot where it receives maximum amount of sunlight throughout the day. 4-5 hours of direct sun exposure is the ideal condition.
2. It may take couple of days for the light to be fully charged and work properly.
3. **If you are replacing an existing gas/electric post light, consult a certified technician to have them removed before installation.**



WARNING:
Do not hold the light by the solar panel or the motor.



Automatic Tracking System positioning throughout the day

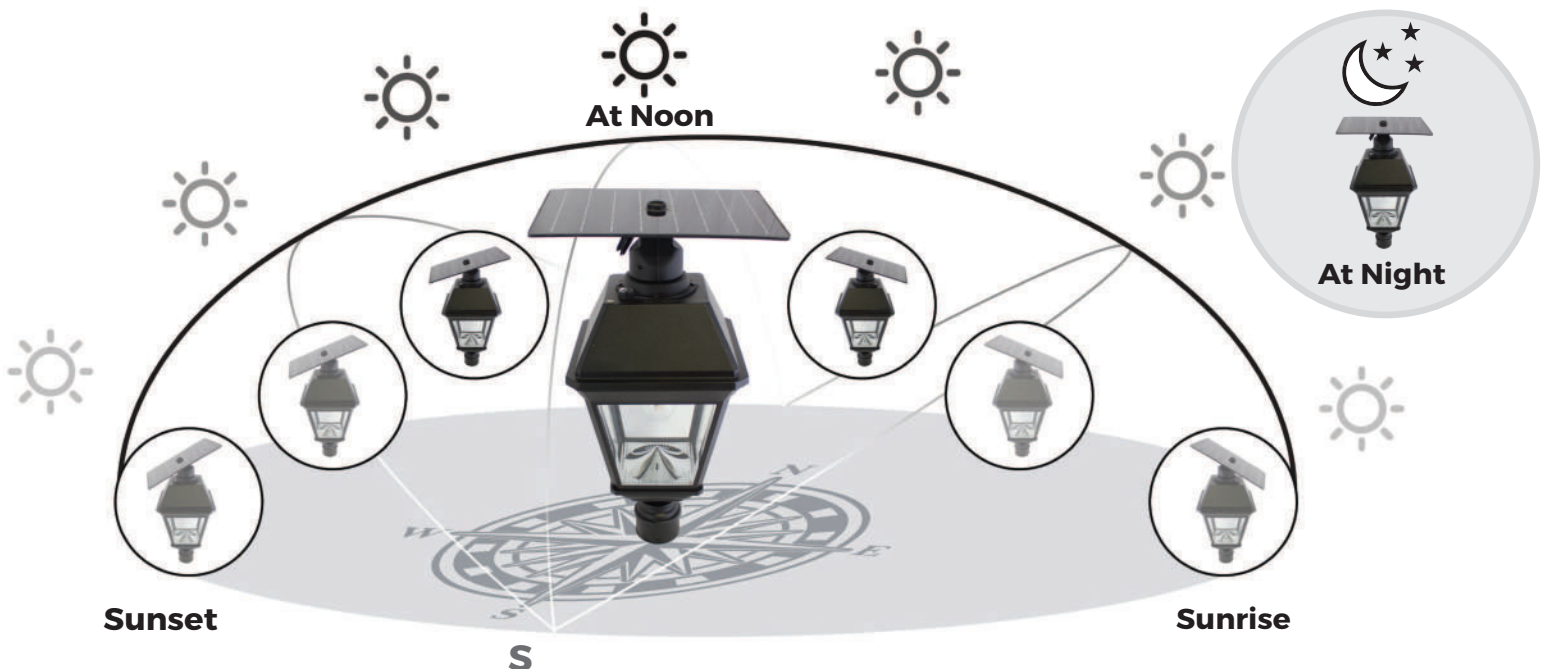

Operation Instructions

1. Detach the upper portion of the lamp as shown in Fig. 1 by turning it counterclockwise.
2. Install the GS Solar LED Bulb by turning into the bulb socket clockwise.

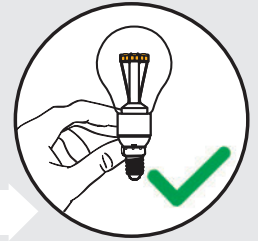

NOTE: Make sure to grip the light bulb by the base only and NOT the glass lens.

3. Turn operation switch "ON" to your desired brightness level (see Fig. 2.)

- **LOW** - Lasts longer using dimmer light.
- **HIGH** - Brighter light output.

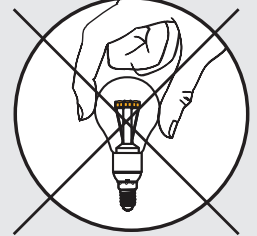

4. Reassemble the upper portion of the lamp by placing it on top of the 4 hinges, and then turn it clockwise.

Fig. 1



Fig. 2



Assembly Instructions

GS-97ATS

1. **VERY IMPORTANT:** Make sure the compass is positioned facing South. (Fig. 3)
2. Place Lamp on top of your existing 3" round post and tighten the 3 set screws provided to secure the lamp (Fig. 4).

Fig. 4



Fig. 3



Replacing the Batteries

Replacement batteries are available
at www.gamasonic.com or via our Toll free number: +1-800-835-4113

Approximately after 2 ½ -3 years, the batteries will need to be replaced.

1. Detach the upper part of the lamp as shown in **Fig. 1** by turning it counterclockwise.
2. Make sure the operation switch is in the OFF position.
3. Remove the battery compartment screws located on the silver reflector and remove the old battery packs as shown in Fig 5. Make sure the new batteries are (3.2V/3000mAh) Li-Ion Rechargeable Gama Sonic Batteries.
4. Install the new batteries into the battery compartment.
5. Reassemble the unit by reversing the above procedure.



WARNING: Do not dispose of Li-Ion batteries in the regular trash, municipal waste stream or by fire as batteries may leak or explode. Do not open, short circuit, or mutilate batteries as injury may occur. Preserve our environment by recycling Li-Ion batteries or disposing of them in accordance with local, State and federal regulations. Do not mix old and new batteries.

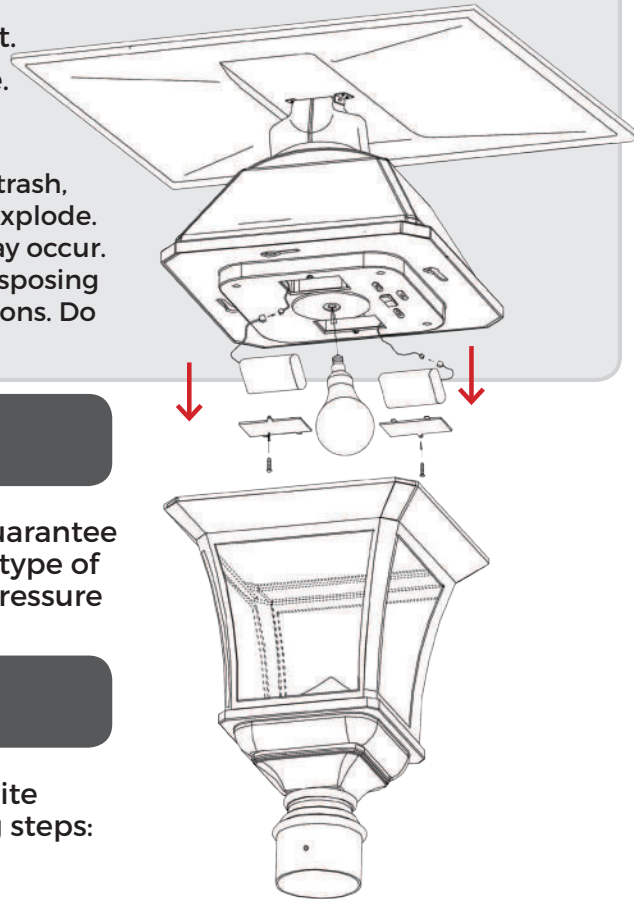

Fig. 5

Maintenance

Clean the solar module regularly with a damp towel to guarantee optimum performance of the solar panel. Do not use any type of solvent for cleaning and be careful not to put too much pressure on the module while cleaning.

Trouble Shooting

If your solar charged light does not come on at dusk despite observance of all the instructions, please try the following steps:

1. Make sure that the solar light is not being affected by any other light source (i.e street lights).
2. Ensure the solar light is not positioned in the shade during the day.
3. Make sure the switch in the lamp head is in the "ON" position.
4. Check that the batteries are installed correctly.

NOTE: The performance of the solar light will vary with the time of year. It will deliver longer duration when it has had a full day in the sun rather than a day in overcast weather.



WINTERTIME TIPS: Keep snow and debris cleaned off the solar panels so the batteries can recharge. If the lights are covered with snow for an extended period of time, after the snow melts, allow all the batteries to charge in full, direct sunlight for at least 6 hours to their maximum capacity.

WARNING: Please keep out of reach of children.

