

GAMA SONIC[®]

SOLAR LIGHTING

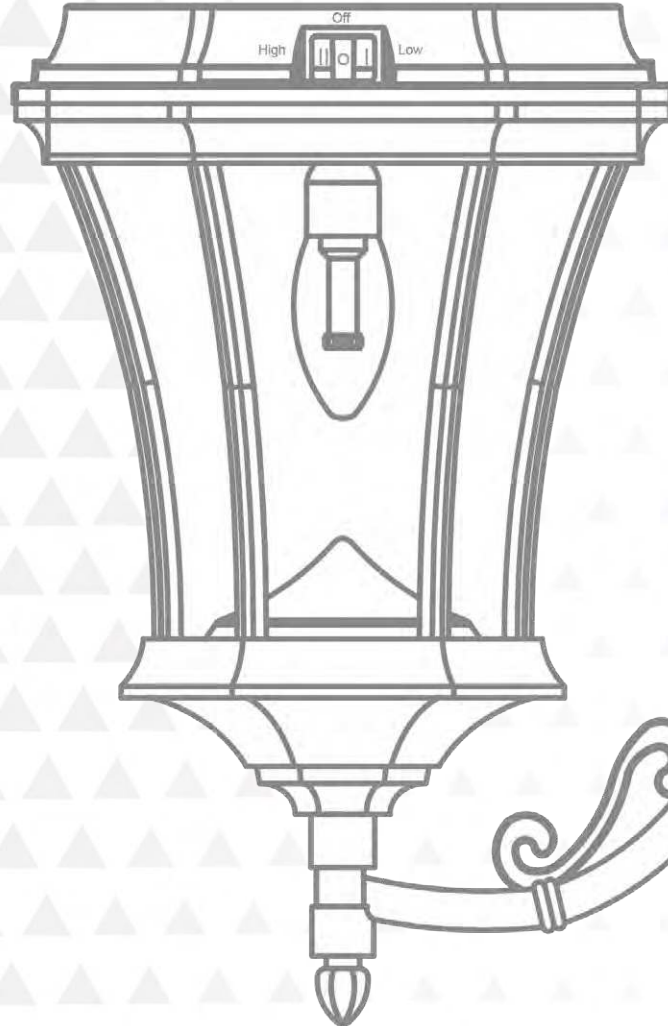
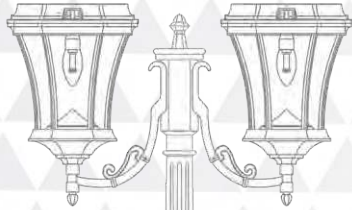

VICTORIAN BULB SOLAR LAMP POST

Part # 94B001, 94B002, 94B003

US patents
7172307, 9458970



Please read the instruction manual carefully to obtain the best results from your purchase.

Thank you for your purchase! GAMA SONIC® solar charged lights are brighter and last all night with a typical solar charge. Unique design, superior light output and numerous installation options confirm the outstanding value of our product. **GAMA SONIC®** has been recognized as a worldwide leader in the lighting industry for over 20 years.

Technical Assistance / Warranty Claims / Replacement Parts
Toll-Free number: +1-800-835-4113 (only within the US) or www.gamasonic.com

Visit our website or download the latest version of your instruction manual:
www.gamasonic.com or www.gamasonic.com/user-guides

Gama Sonic's Bulb Technology

Gama Sonic's patented Bulb technology gives your solar lamp the look and feel of a traditional incandescent lamp. This helps to distribute light further than traditional solar lamps.

Solar Lamp Location

For optimum light duration throughout the night, it is very important to mount your solar lamp in a spot where it will receive the maximum amount of direct sunlight throughout the day.

NOTE: For best results, the solar light must be charged in the "High or Low" position for at least 2 days of full direct sunlight.

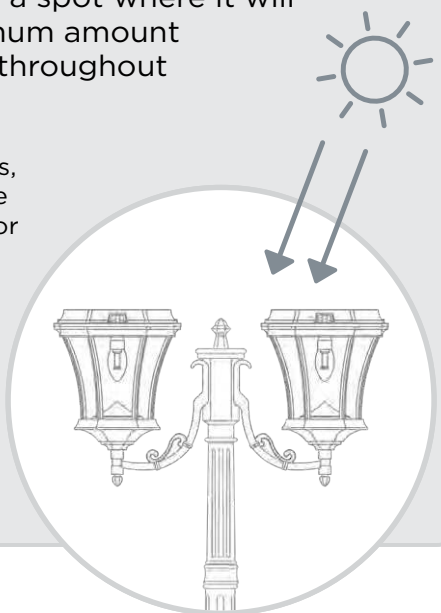

What's In The Box

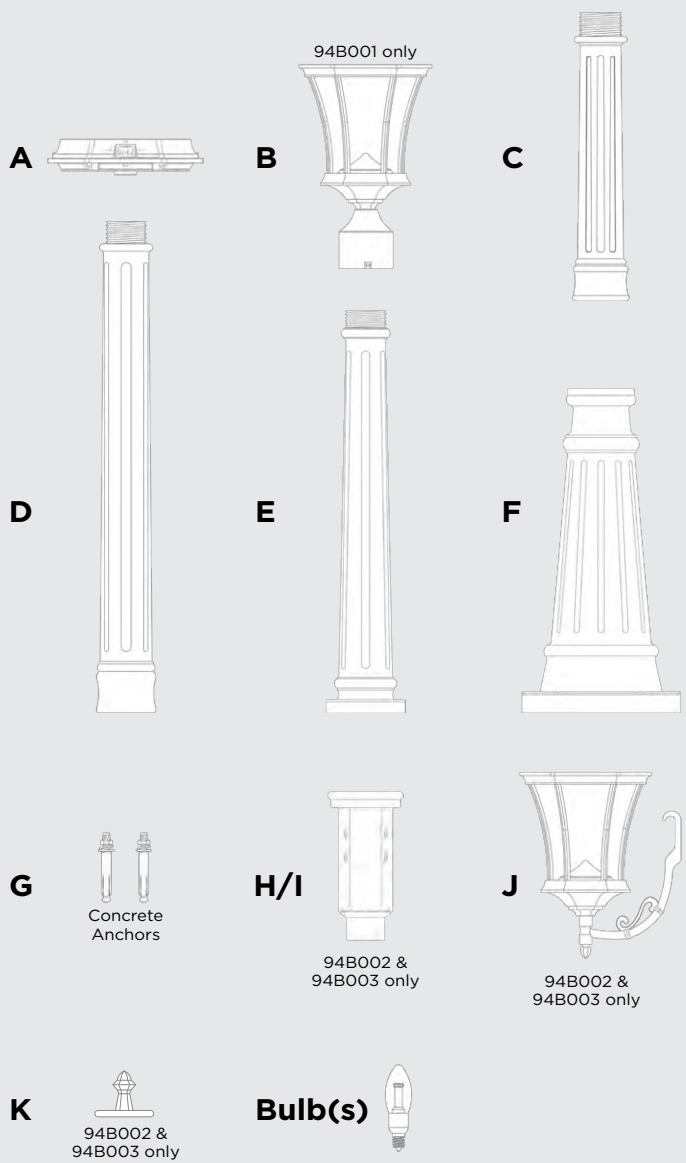

Assembly Instructions

94B001

1. Using the provided template, mark and drill three holes into concrete no larger than the provided anchors (G).

NOTE: For installation in the ground where pouring concrete is not preferred or possible, use our EZ Lamp Post Anchor, model 30001 (sold separately) to quickly and easily secure the lamp anywhere in your yard. This is only to be used with model 94B001.

2. Place the anchors (G) into the holes with the threaded ends facing up.
3. Place the Base Pole (F) over the anchors and secure using a wrench. Cover the nuts with the provided plastic covers.
4. Place the middle pole (E) on top of the base pole (F) and secure with the provided screws.
5. Attach the top pole (D) to the middle pole (E), and the spacer pole (C) to the top pole (D) by screwing the poles clockwise.
6. Attach the fixture (B) to the spacer pole (C) by twisting clockwise.

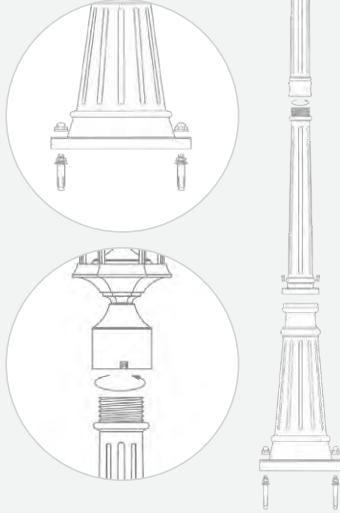

94B002/94B003

1. Using the provided template, mark and drill three holes into concrete no larger than the provided anchors (G). (follow along with illustration above for steps 1-5)
2. Place the anchors (G) into the holes with the threaded ends facing up.
3. Place the Base Pole (F) over the anchors and secure using a wrench. Cover the nuts with the provided plastic covers.
4. Place the middle pole (E) on top of the base pole (F) and secure with the provided screws.
5. Attach the top pole (D) to the middle pole (E), and the spacer pole (C) to the top pole (D) by screwing the poles clockwise.
6. Remove the finial cap (K) from the centerpiece (H/I) by removing the screws.
7. Insert one of the fixtures with arms (J) into the centerpiece (H/I).
8. Screw in two bolts through the holes in the arm (J) into the centerpiece (H/I) using the supplied hex wrench.
9. Secure the two bolts using a nut inside the centerpiece (H/I).
10. Repeat the installation for the second and third lamp head (only second if installing double head lamp).
11. Replace the finial cap (K) on the centerpiece (H/I) and secure using the screws removed earlier.
12. With the help of another person, place the assembly of lamp heads and centerpiece (H/I) on top of the spacer pole (C) and twist clockwise until fully attached to the pole.

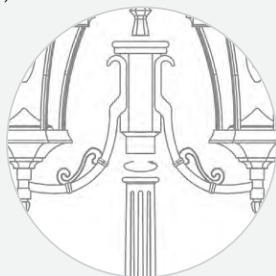
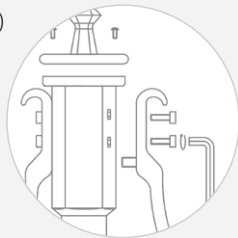

Operation Instructions

1. Remove the top (A) from the Fixture by removing the two screw caps.
2. Install the GS Solar LED Bulb by holding it by the base and twisting it clockwise into the socket.
3. Replace the top (A) back on the fixture and secure with the two screw caps.
4. Using the external switch, select your desired setting.
Low = Softer light output and longer duration
High = Brighter light output
5. The lamp will operate automatically at dusk.

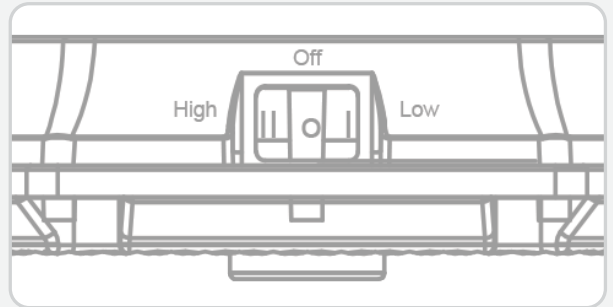

Replacement Parts

Replacement Batteries and Bulbs are available at www.gamasonic.com or via our Toll Free number: +1-800-835-4113

Your Lamp can use the following bulbs:

C37WW10W – included bulb with Warm White LEDs (2700K)

C37BW10W – bulb with Bright White LEDs (6000K)

F30WW05W – Flame bulb with simulated flame LEDs

T45WW10W – Edison LED Bulb with Warm White LEDs (2700k)

Your Lamp uses the following batteries:

GS32V30



Replacing the battery

GAMA SONIC®
SOLAR LIGHTING

After several years of use, the battery may need replacing.

1. Make sure the lamp is in the OFF position.
2. Remove the top (A) from the fixture by removing the two screw caps.
3. Remove the GS Solar LED Bulb.
4. Remove the screw from the battery compartment cover on the silver reflector on the underside of the top (A).
5. Remove the battery and unclip the connector.
6. Make sure the new battery is a Gama Sonic – 3.2V/3,000mAh (Item GS32V30), Li-Ion Rechargeable Battery with matching connector.
7. Clip in the new battery and install it into the battery compartment.
8. Re-assemble the top (A) by reversing steps 2-4.
9. Switch the lamp ON to your desired setting.

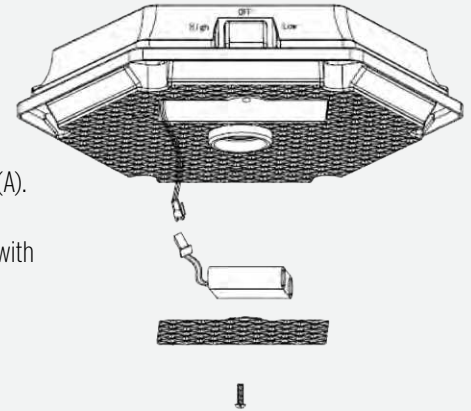

Batteries are available for purchase at www.gamasonic.com

WARNING: Do not dispose of Li-Ion batteries in the regular trash, municipal waste stream or by fire as batteries may leak or explode. Do not open, short circuit, or mutilate batteries as injury may occur. Preserve our environment by recycling Li-Ion batteries or disposing of them in accordance with local, State, and federal regulations. Do not mix old and new batteries.

Maintenance

Clean the solar panels regularly with a damp towel to guarantee optimum performance. Do not use any type of solvent for cleaning and be careful not to put too much pressure on the solar panels while cleaning.

Troubleshooting

If your solar light does not come on as expected despite observance of all the instructions, please try the following steps:

1. Make sure that the solar lamp is not being affected by any other light source.
2. Ensure the solar lamp is not positioned in the shade during the day.
3. Check that the batteries are installed correctly.

NOTE: The performance of the solar lamp will vary with the time of year. It will last longer when it has had a full day in the sun rather than a day in overcast weather.



WINTERTIME TIPS: For optimal performance, be sure to remove any snow or debris accumulation from solar panel(s). A solar panel free of debris will charge the batteries much more efficiently.

WARNING: Please keep out of reach of children. Do not dispose of the Li-Ion battery in the regular trash, municipal waste stream or by fire as batteries may leak or explode. Do not open, short circuit, or mutilate batteries as injury may occur. Preserve our environment by recycling Li-Ion batteries or disposing of them in accordance with local, State and federal regulations. Do not mix old and new batteries.