

GAMA SONIC[®]

SOLAR LIGHTING

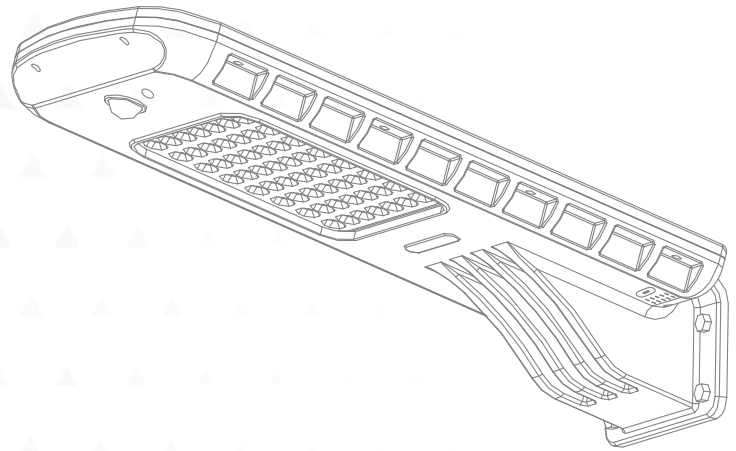

20W Solar Security & Area Light with Motion Sensor and Timer

Part #: 301iST60822

Version 1.1

 Please read the instruction manual carefully to obtain the best results from your purchase.

Thank you for your purchase. GAMA SONIC® solar charged lights are brighter and last all night with a full day solar charge. Unique designs, superior light output and numerous installation options confirm the outstanding value of our product.

GAMA SONIC® has been recognized as a worldwide leader in the lighting industry for over 20 years.

For technical assistance and more information call our Toll-Free number:

800-835-4113
(only within the US)

Or

visit our website or download the latest version of your instruction manual:

www.gamasonic.com Or
www.gamasonic.com/user-guides

Package Contents

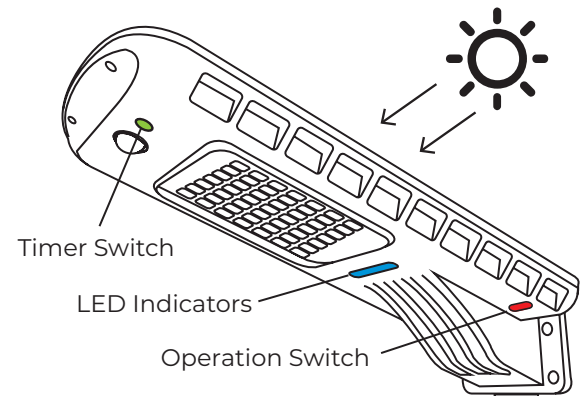
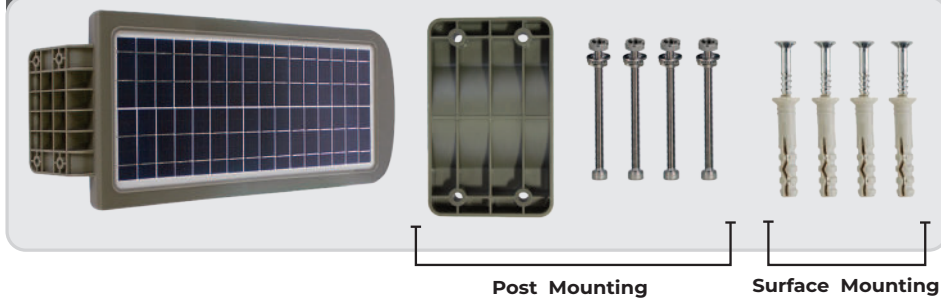

✓ Operation Switch

Place the lamp in one of the two operating settings:

On: The lamp will constantly be on at 980 Lumens for the first four hours. After that, it will be reduced to 210 Lumens and increase to 980 Lumens when motion is detected for 30 seconds.

PIR: The lamp will remain off until motion is detected after dusk. When motion is detected, it will shine at 2,880 Lumens for one minute.



✓ Timer Switch

The timer switch works for both operation settings and controls the overall length of time the lamp will function for.

Using a small flathead screwdriver, turn the arrow to the following settings:

0 = Dusk to Dawn operation

4,5,6,7,8 = The number of hours the lamp will operate from Dusk.

Note: When using lamp in "On" setting, the lamp will still be bright for the first four hours and will cease operating after the total hours on the Timer Switch has elapsed. Example: when timer is set to 6, the lamp will dim to 210 Lumens for two hours.

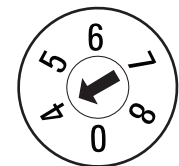

✓ LED Indicators

This lamp has 5 LED indicators on the underside of the product. When looking at the product, the cluster of 3 red LEDs indicates the level of charge the battery has. The two blue LEDs indicate if the battery is receiving a charge in the day time and when the lamp is functioning at night.

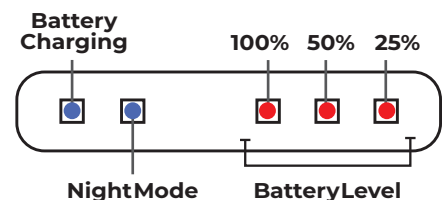

Note: The indicator that the lamp is functioning at night will illuminate even when the lamp does not sense motion. This indicator is to let you know it will turn on when motion is detected.

*Pole not included

Possible places to install the 301iST60822:

- Outside Garage • House Entryway • Patios • Garden • Driveway
- Camping Site • Rural Street • Farm • Green Belts • Square

GAMA SONIC®
SOLAR LIGHTING

✓ Solar Lamp Location

For optimum light duration throughout the night, it is very important to mount your solar lamp in a spot where it will receive the maximum amount of direct sunlight throughout the day.

Post Mount:

Assemble hardware to fixture housing as shown in the image (make sure the curved side of the mount faces in). Slide fixture over light post so the curved side of the mount hugs the light pole. Adjust the light to the desired height and position. Then tighten the four bolts.

CAUTION: DO NOT OVERTIGHTEN SCREWS

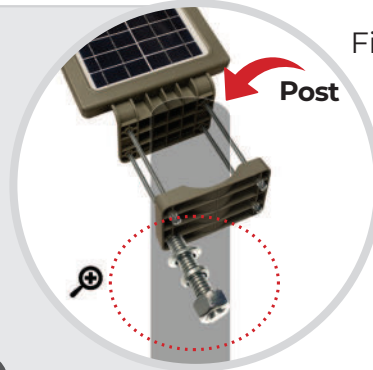

Fig. 1



Diameter
2-3 inches

8 - 15 feet

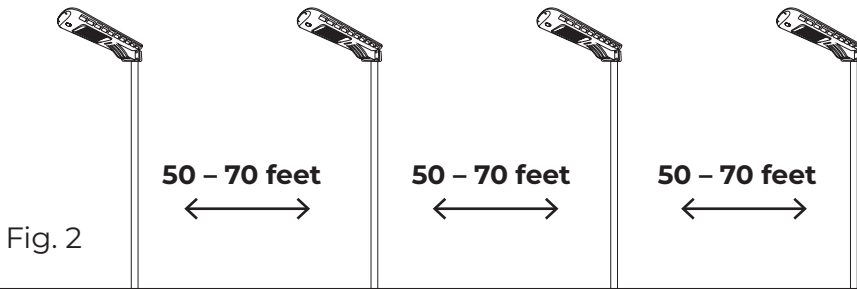

Fig. 2

Advice: Ideal pole height: 8 - 15 feet; ideal pole diameter: 3 inches.

If multiple lights are purchased, install between 50-70 feet apart for optimal light spread.

Surface Mount:

Make sure the alignment of your mounting location is level and even for your solar light installation. Drill four holes into your desired installation surface using the lamp as a template and place anchors in to the holes. Position the four provided screws through the holes of the lamp and into the anchors. Tighten the screws to secure the lamp to the surface.



Note: There are specific types of screws for different surfaces. If you're unsure of the appropriate type of screw to use on your desired surface, please consult a professional.

*Pole not included



Replacing the Batteries

After several years of use, the battery may need replacing.

1. Remove the lamp from where it is mounted and turn upside down.
2. Remove all 12 screws from the underside of the security light and remove the solar panel.
3. Remove the battery bracket by unscrewing the two screws holding it in place.
4. Unclip the battery connector and remove the old battery. Make sure the new battery is a high quality – 1x Li-Ion Battery pack (3.2V/24Ah, Item# GS32V24A) with matching connector.
5. Install the new battery into the battery compartment.
6. Re-assemble by reversing Steps 1-3.

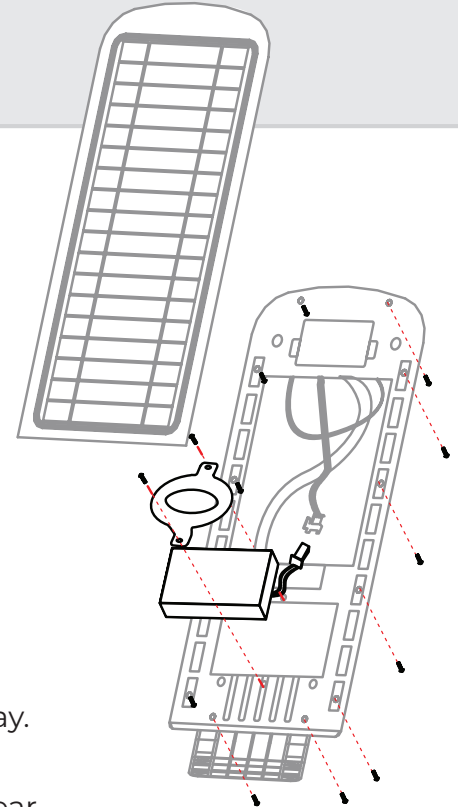

Maintenance

Clean the solar panels regularly with a damp towel to guarantee optimum performance. Do not use any type of solvent for cleaning and be careful not to put too much pressure on the solar panels while cleaning.

Troubleshooting

If your solar charged light does not come on at dusk despite observance of all the instructions, please try the following steps:

1. Make sure that the solar light is not being affected by any other light source (i.e street lights).
2. Ensure the solar light is not positioned in the shade during the day.
3. Check that the batteries are installed correctly.

NOTE: The performance of the solar lamp will vary with the time of year. It will last longer when it has had a full day in the sun rather than a day in overcast weather.



WINTERTIME TIPS: For optimal performance, be sure to remove any snow or debris accumulation from solar panel(s). A solar panel free of debris will charge the batteries much more efficiently.



WARNING: Please keep out of reach of children. Do not dispose of the Li-Ion battery in the regular trash, municipal waste stream or by fire as batteries may leak or explode. Do not open, short circuit, or mutilate batteries as injury may occur. Preserve our environment by recycling Li-Ion batteries or disposing of them in accordance with local, State and federal regulations. Do not mix old and new batteries.

Please keep out of reach of children.