

QUESTIONS OR CONCERNS CONTACT CANARM AT:

1-800-265-1833 (English) / 1-800-567-2513 (French) Monday through Friday 8:00 AM to 5:00 PM E.S.T.

"INSTRUCTIONS PERTAINING TO RISK OF FIRE OR INJURY TO PERSONS"
"READ ALL INSTRUCTIONS"

"IMPORTANT SAFETY INSTRUCTIONS"

"SAVE THESE INSTRUCTIONS"

TOOLS AND MATERIALS REQUIRED:

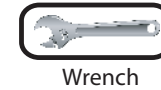
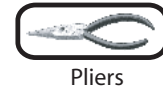

Wiring supplies as required by the Canadian Electrical Code and/or the Quebec Electrical code

SAFETY PRECAUTIONS:

1. **TURN OFF ELECTRICAL POWER BEFORE STARTING INSTALLATION OF LIGHT FIXTURE.**
2. **THIS PRODUCT MUST BE INSTALLED IN ACCORDANCE WITH THE APPLICABLE INSTALLATION CODE BY A PERSON FAMILIAR WITH THE CONSTRUCTION AND OPERATION OF THE PRODUCT AND THE HAZARDS INVOLVED.**
3. **FIRMLY ATTACH THE FIXTURE GROUND WIRE (BARE COPPER) TO THE MOUNTING BRACKET WITH THE GROUND SCREW (BY WRAPPING AROUND THE GROUND SCREW) AND THEN CONNECT IT TO THE HOUSE SUPPLY GROUND WIRE WITH A WIRE NUT.**

INSTALLATION: NOTE: Product May Not Look Exactly As Shown In Figures.

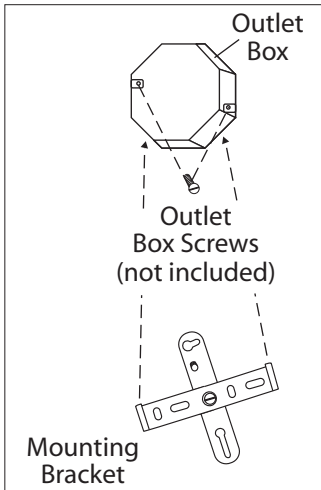

1. Mount the mounting bracket to outlet box using outlet box screws (not included). Make sure the studs or nipple on the mounting bracket are facing out from the outlet box.

2. Align the mounting bracket so the fixture will be square. Tighten the centre screw to lock the mounting bracket in the correct position.

3. Firmly attach the fixture ground wire (bare copper) to the mounting bracket with the ground screw (by wrapping around the ground screw) and then connect it to the house supply ground wire with a wire nut. Connect the black wire (or wire with marking) from the fixture to the black wire in the electrical box and connect the white wire from the fixture to the white wire in the electrical box.

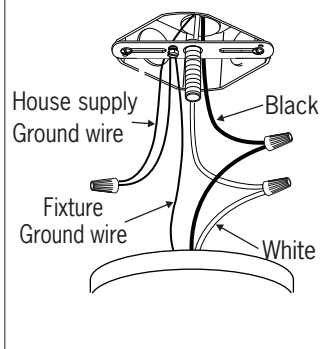

4. Once connections of wires are completed, carefully tuck wires and wire nuts into the outlet box making sure no bare wire (on the black and white) is visible at the wire nuts.

Style #1 - Position fixture over the mounting bracket. Line up the screw holes in the bracket to to the screw holes on the fixture. Insert screws and tighten to secure fixture in place.

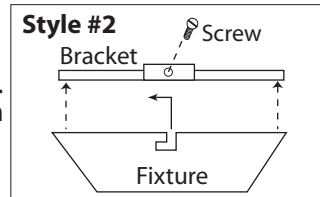
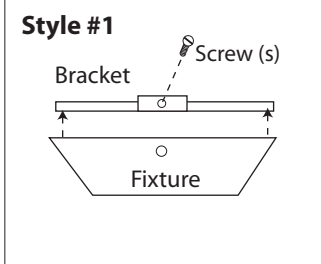

Style #2 - Insert one screw into the mounting bracket - do not tighten yet. Tuck electrical wires into outlet box and position fixture over the mounting bracket. Line up the screw in the bracket to to the "7" hole on the fixture. Slide fixture to secure in place. Insert remaining screw. Tighten both screws to secure.

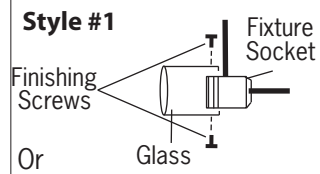

5. Style #1 - Install proper bulb type and wattage. Remove the finishing screws that are already on your fixture. Position glass in place and secure with finishing screws. Install the proper bulb type and wattage (not included).

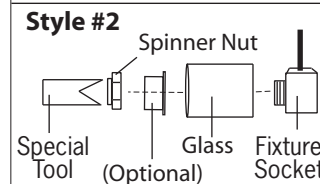
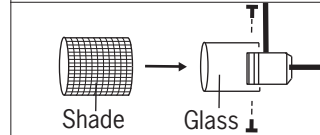

Style #2 - Remove spinner nut from the socket. Place the glass onto the fixture socket. Use the special tool that comes with your fixture to tighten the spinner nut onto the socket to secure the glass in place. Install the proper bulb type and wattage (not included).

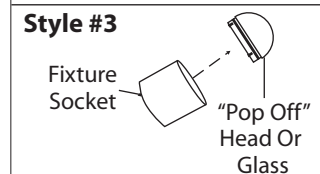

Style #3 - Snap "pop off" head or glass onto fixture (push, or push and turn (it depends on the style of your fixture)). Install proper bulb type and wattage (not included).

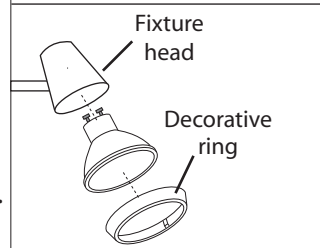

6. Install proper bulb type and wattage (not included). Install decorative ring.