

QUESTIONS OR CONCERNS CONTACT CANARM AT:
1-800-265-1833 (English) • 1-800-567-2513 (French)
Monday through Friday 8:00 AM to 5:00 PM E.S.T.



SAFETY PRECAUTIONS:

1. TURN OFF ELECTRICAL POWER BEFORE STARTING INSTALLATION OF LIGHT FIXTURE. DO NOT REMOVE INSULATION FROM FIXTURE.
 2. THIS PRODUCT MUST BE INSTALLED IN ACCORDANCE WITH THE APPLICABLE INSTALLATION CODE BY A PERSON FAMILIAR WITH THE CONSTRUCTION AND OPERATION OF THE PRODUCT AND THE HAZARDS INVOLVED.
 3. CAUTION – RISK OF FIRE. CONSULT A QUALIFIED ELECTRICIAN TO ENSURE CORRECT BRANCH CIRCUIT CONDUCTOR.
- NOTE: Product May Not Look Exactly As Shown In Figures.**

INSTALL EASY CONNECT MOUNTING BRACKET: STEP 1

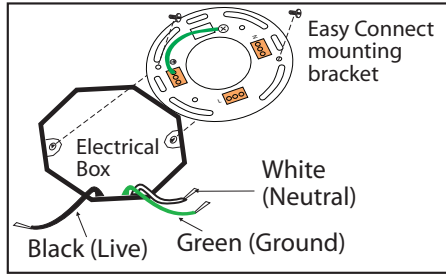

Attach easy connect mounting bracket to electrical box with electrical box screws (not included).

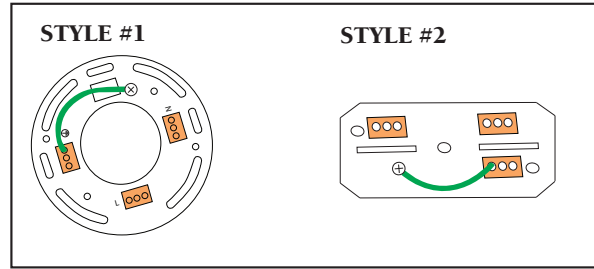

CONNECT HOUSE WIRES STEP 2 - Option 1

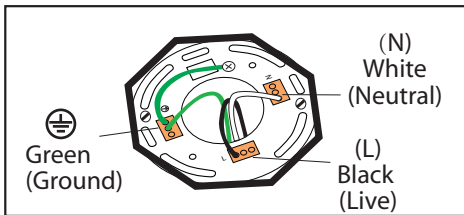

Connect (push) electrical wires from electric box (house wiring) into correct inserts. Black (Live), White (Neutral), Green (Ground)

Option 2 - MULTIPLE ELECTRICAL BOX WIRES

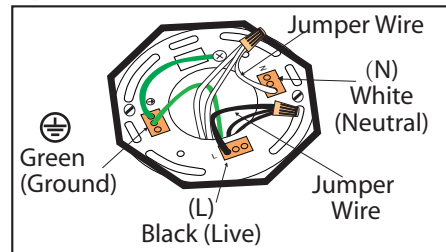

For multiple black (live) & white (neutral) wires joined in the electrical box (house wiring), attach a single "black" and "white" Jumper Wire before connecting. Strip 7mm from a 6" Jumper Wires (AWG 12-24) supplied. Then connect (push) wires into correct inserts.

CONNECT LIGHT FIXTURE STEP 3

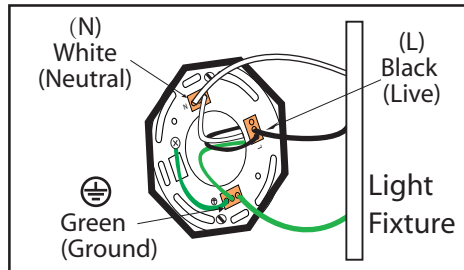

Connect (push) electrical wires from fixture into correct inserts. Black (live), White (neutral), Green (ground)

STEP 4 - Note: Refer to the style of assembly that matches the style of your fixture.

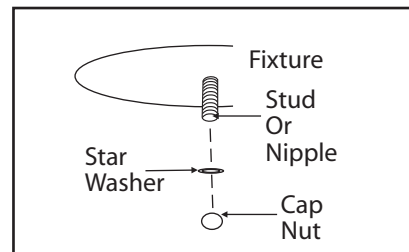

Tuck electrical wires into outlet box and position fixture over studs or nipple on mounting bracket assembly. Secure fixture in place with star washer(s) and cap nut(s).
Note: If required, assemble body and spread the arms of the fixture out evenly.

STEP 5 - Note: Refer to the style of assembly that matches the style of your fixture.

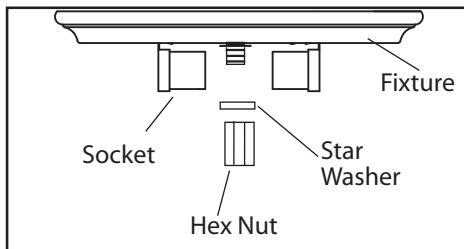

Install the pan through the centre screw stud. Secure the pan using a star washer and hex nut.

STEP 6 - Note: Refer to the style of assembly that matches the style of your fixture.

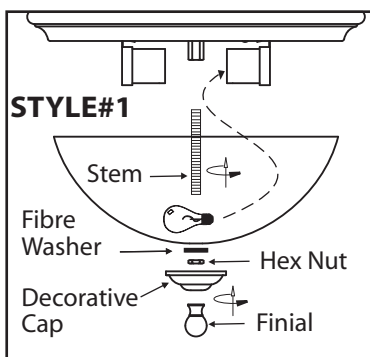

STYLE#1 - Secure the centre stem onto the screw stud. Install the proper bulb type and wattage. Secure the glass in place using the decorative cap, hex nut, fibre washer and finial.

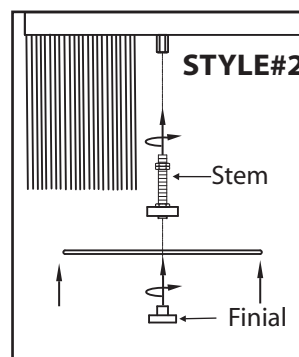

STYLE#2 - Secure the centre stem onto the screw stud. Install the proper bulb type and wattage. Secure the glass in place by the finial.