

# Artemide®

## Megaron

design  
G. Frattini

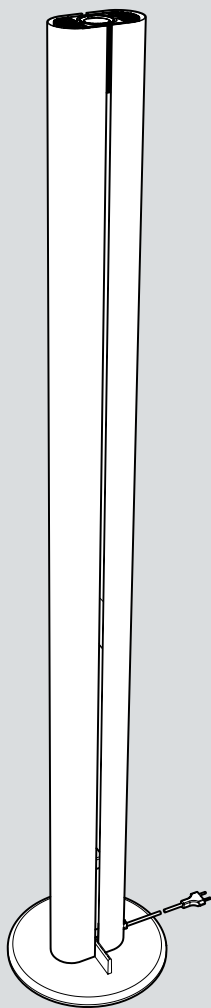



i

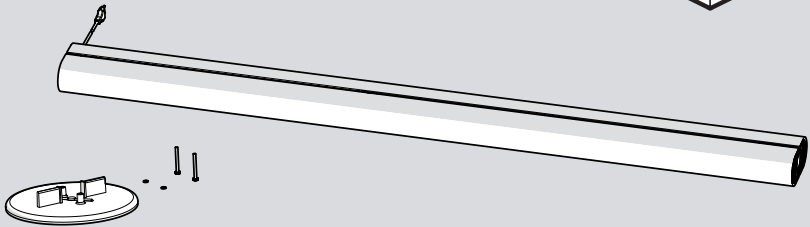
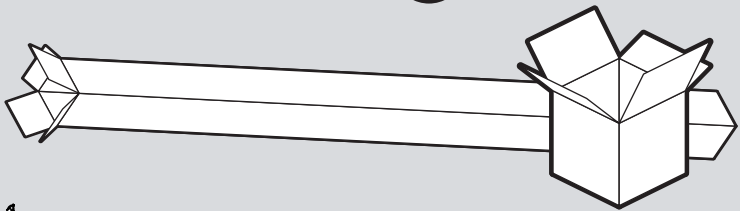
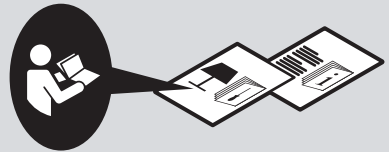
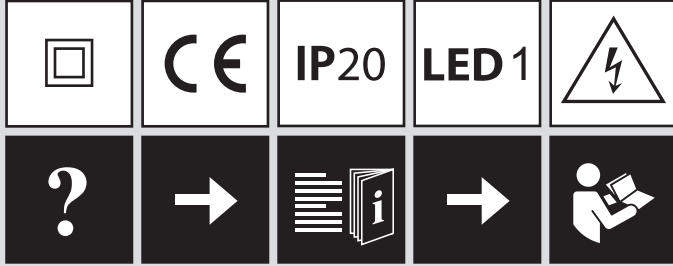

1

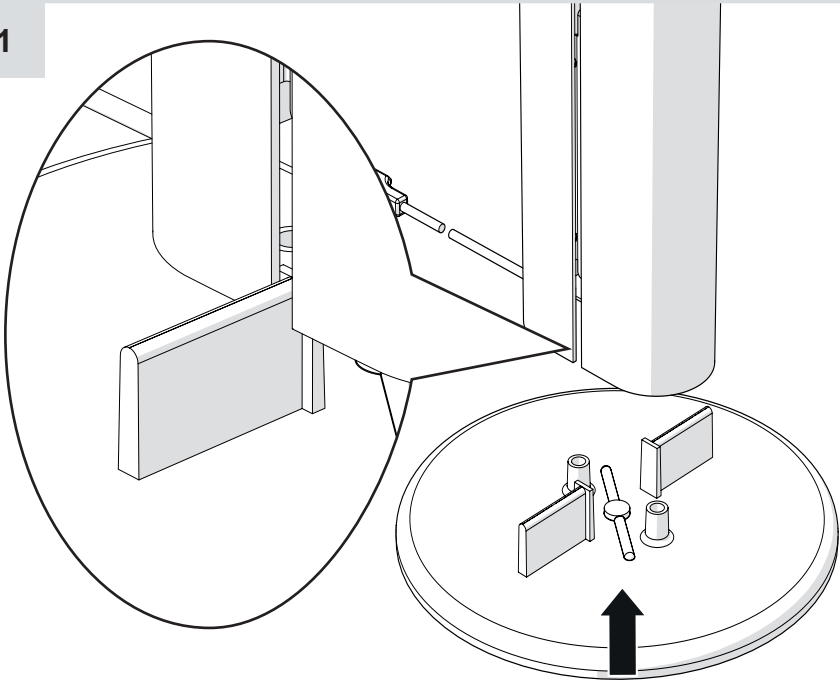

2

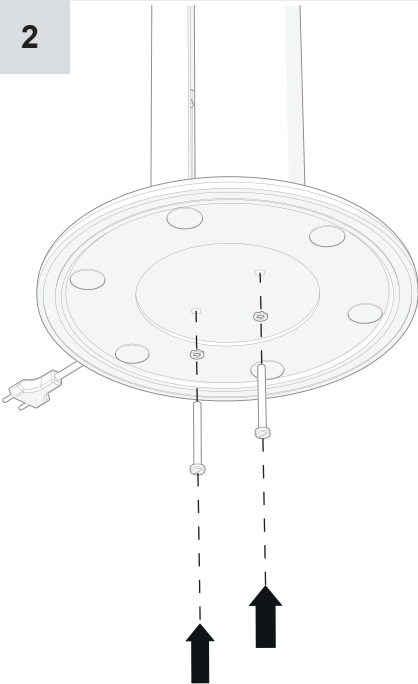

3

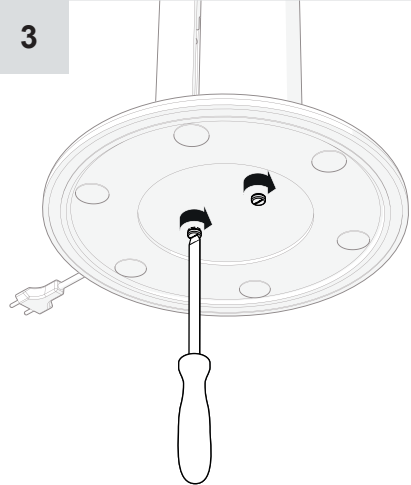

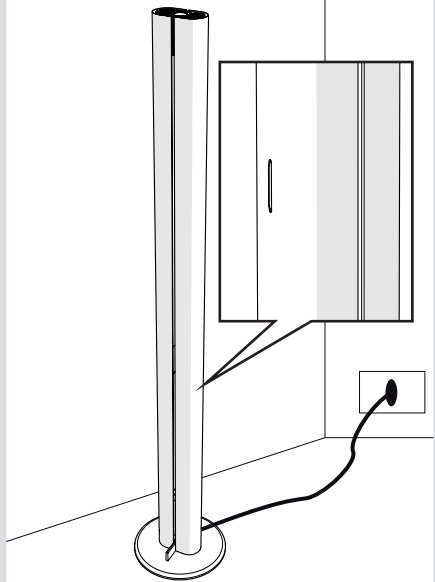
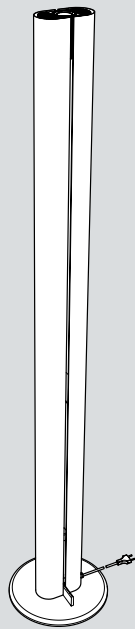

**i**

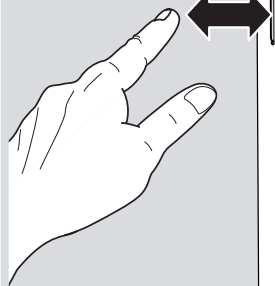
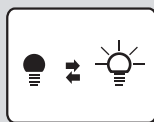

**i**

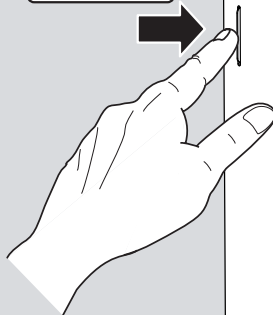
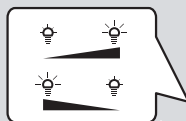

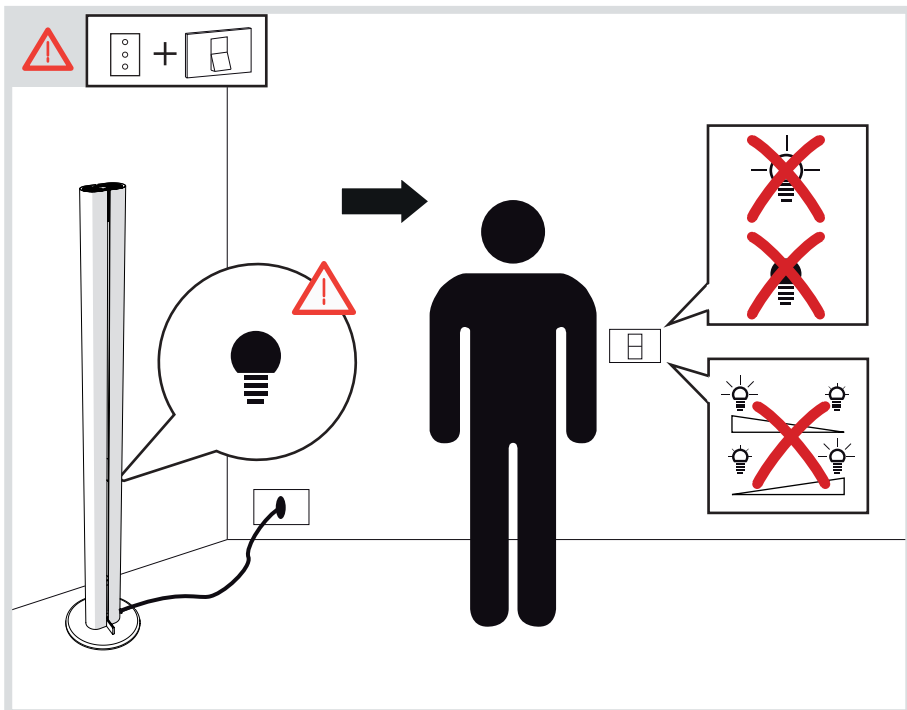
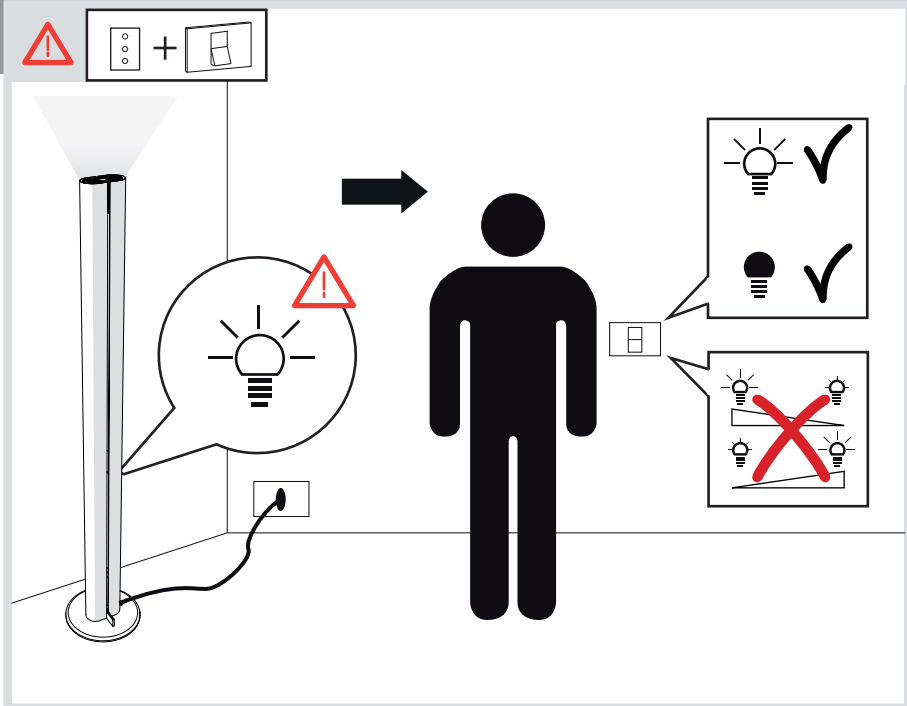



i

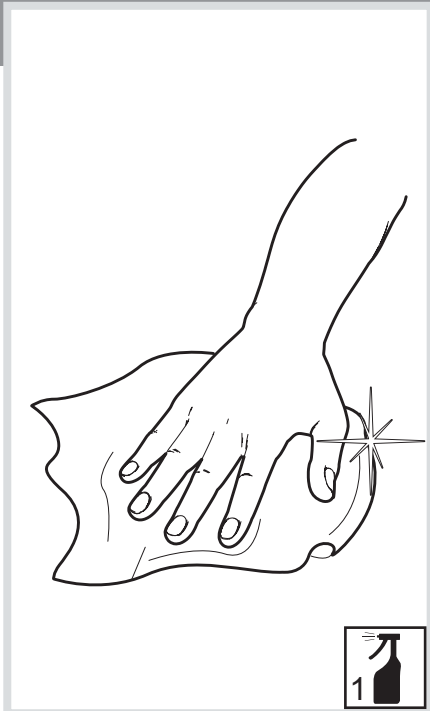
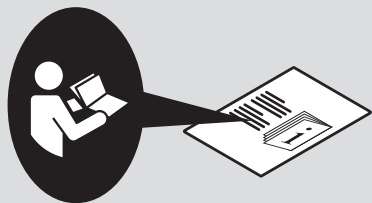



**Artemide®**

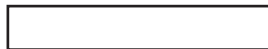

## **Artemide**

via Bergamo, 18  
20010 Pregnana M.se (MI)  
ITALIA

tel. +39 02 935 181  
fax +39 02 935 90 254  
fax +39 02 935 90 496

[www.artemide.com](http://www.artemide.com)

VAT IT00846890150

cod. Y513000178A