

ASSEMBLY AND INSTALLATION INSTRUCTIONS

WARNING: Be sure the electricity to the wires you are working on is shut off, either the fuse is removed or the circuit breaker is shut off.

NOTE: Before installing, consult local electrical codes for wiring and grounding requirements.

Carefully remove the fixture from the carton, and check that all parts are included, as shown in figure. Be careful not to misplace any of the screws or parts which are needed for installing the fixture.

Assembly and Installation Step:

1. Make wire connections with wire nuts:

- a. The black wire from fixture to the black wire from power source.
- b. The white wire from fixture to the white wire from power source.
- c. Attach the ground wire from the fixture to the outlet box ground screw or to the green screw located on the crossbar.

2. Place the Fixture to the Post, and then secure with 3 Mounting Screws.

3. Remove the Cover by unscrew, and install bulb (not included)

4. Attach the Cover onto the Fixture body, and then secure with 2 Set Screws.

5. Turn on the power at fuse or circuit box.

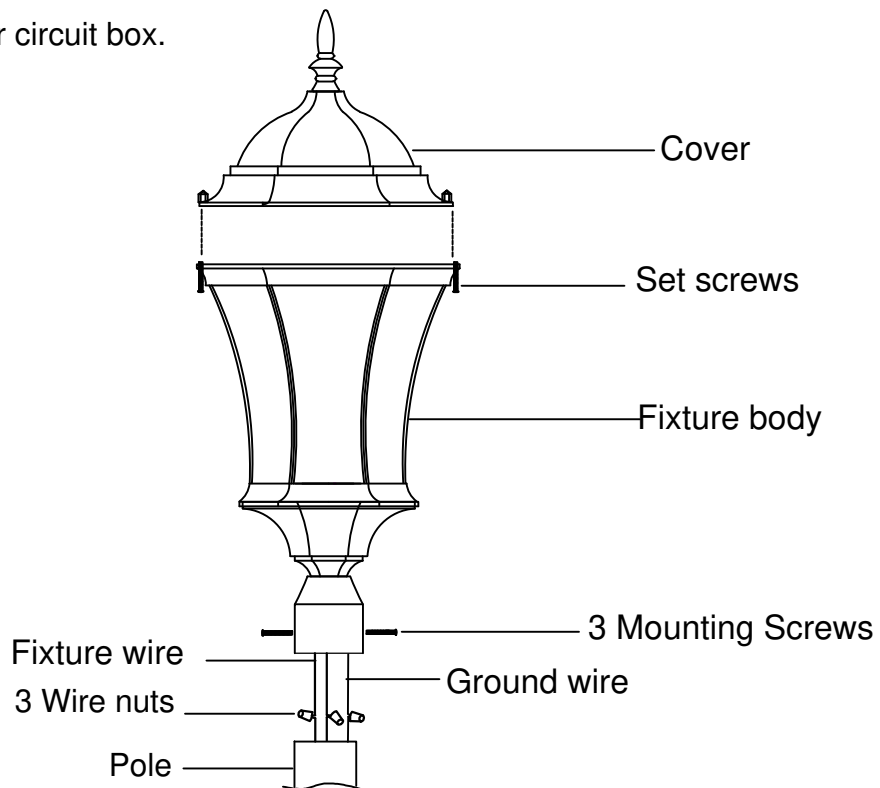

522PHM

Please observe local building/electrical codes regarding the installation of your post fixture. Please keep in mind your geographic location and the depth that the ground freezes to, when deciding the depth of your installation.

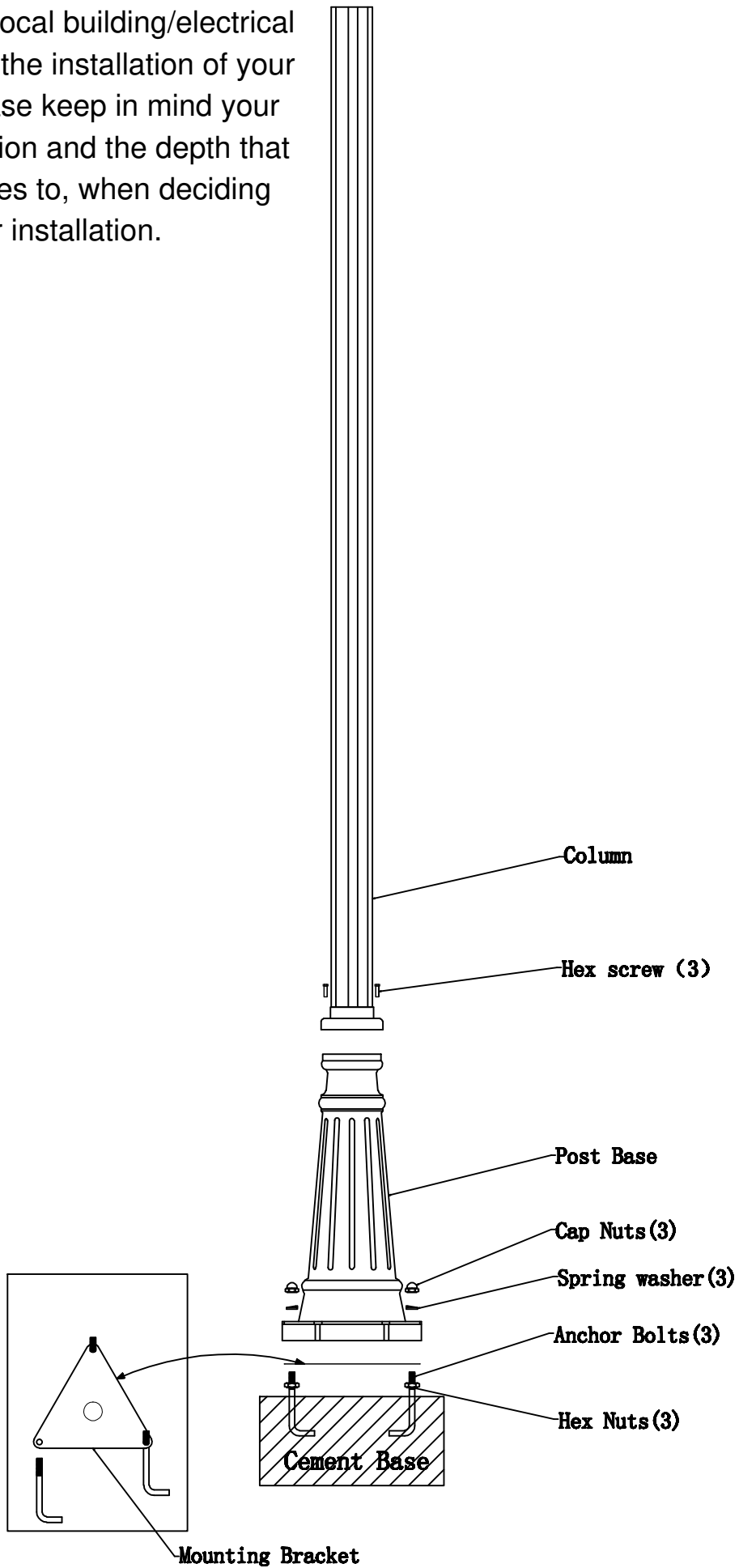

519P-BK