

LED Lamp Wall Sconce

WS9809
INSTALLATION SHEET

START FROM HERE

- Make sure power is completely off at the fuse box.
- Have your fixture installed by a qualified licensed electrician
- Prepare everything in a clear area.
- Wear gloves at all times during this installation.
- Read instructions carefully before you start assembly.
- Keep this instruction sheet for future reference.

Technical Support: 1-855-855-8926

Please Note:

- All Kuzco LED fixtures come with pre-wired LED module(s).
- Unless instructed to do so, please do not touch any part of the LED module(s) as any unnecessary contact with the module could cause permanent damage.
- For dimming, an ELV (Electronic Low Voltage) type of dimmer is required.

- 1.** Remove the fixture from its original packaging. Remove the mounting plate (**1c**) from within the canopy (**2a**) by unscrewing the decorative nuts (**1e**). Attach the mounting plate to the electrical junction box (**1a**), using the two screws (**1d**) provided in the hardware package.
- 2.** Attach the canopy to the mounting plate. First attach all wiring with the provided wire nuts (**1b**) (white to white "N", black to black "L", ground to ground "G"). Secure the canopy (**2a**) with the decorative nuts (**1e**) to the mounting plate (**1c**).
- 3.** If top and bottom plates (**2c**) are not attached, secure with the screws provided in the hardware package. Once this is complete, gently slide the diffuser (**2b**) onto the fixture starting from the top to bottom.
- 4.** You have now completed the installation of your fixture, please enjoy.

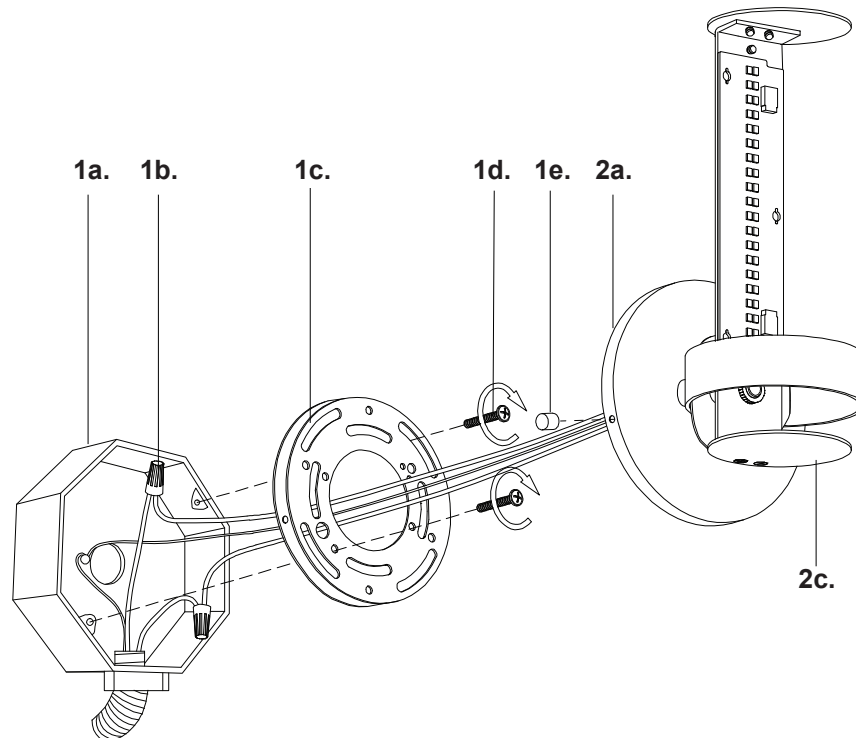
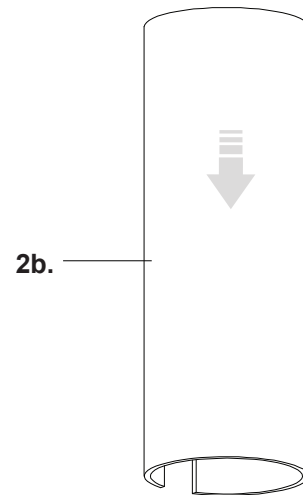

KUZCO

19054 28th Avenue Surrey, BC Canada V3S 6M3
T: 604 538 7162 TF: 1-855 85 KUZCO F: 604 538 7196
W: kuzcolighting.com
20190219