

LED Wall Sconce

WS25125

INSTALLATION SHEET

START FROM HERE

- Make sure **POWER** is **COMPLETELY OFF** at the fuse box
- Have your fixture installed by a qualified licensed electrician
- Prepare everything in a clear area
- Wear gloves at all time during this installation
- Read instructions carefully before you start assembly
- Keep this installation sheet for future reference

Technical Support: 1-855-855-8926

Please Note:

- This Kuzco LED fixtures come with pre-wired LED module(s)
- Unless instructed, Do Not touch any part of the LED module(s) as any unnecessary contact with the module could cause permanent damage
- Use ELV (Electronic Low Voltage) or TRIAC type of dimmer for dimming application

1. Remove fixture from its original package
2. Separate canopy (2a) from fixture body (3a) by loosening set screws with allen key (2b)
3. Separate mounting plate (1c) from canopy (2a) by removing screws (1g)
4. Attach mounting plate (1c) to electrical junction box (1a) using screws provided (1e) in hardware package
5. Attach canopy (2a) to mounting plate (1c) and secure with screws (1g)
6. **Optional Single Gang Box Installation:** Attach mounting plate (1j) to electrical junction box (1a) using screws provided (1e) in hardware package
7. Make proper electrical connections (black to hot "L", white to neutral "N", ground to "GND") with wire nuts (1b) provided in hardware package
8. Attach fixture body (3a) to canopy (2a) or mounting plate (1j) and then secure with set screws with allen key (2b)
9. Insert lamp head (3c) into socket on fixture body (3a)

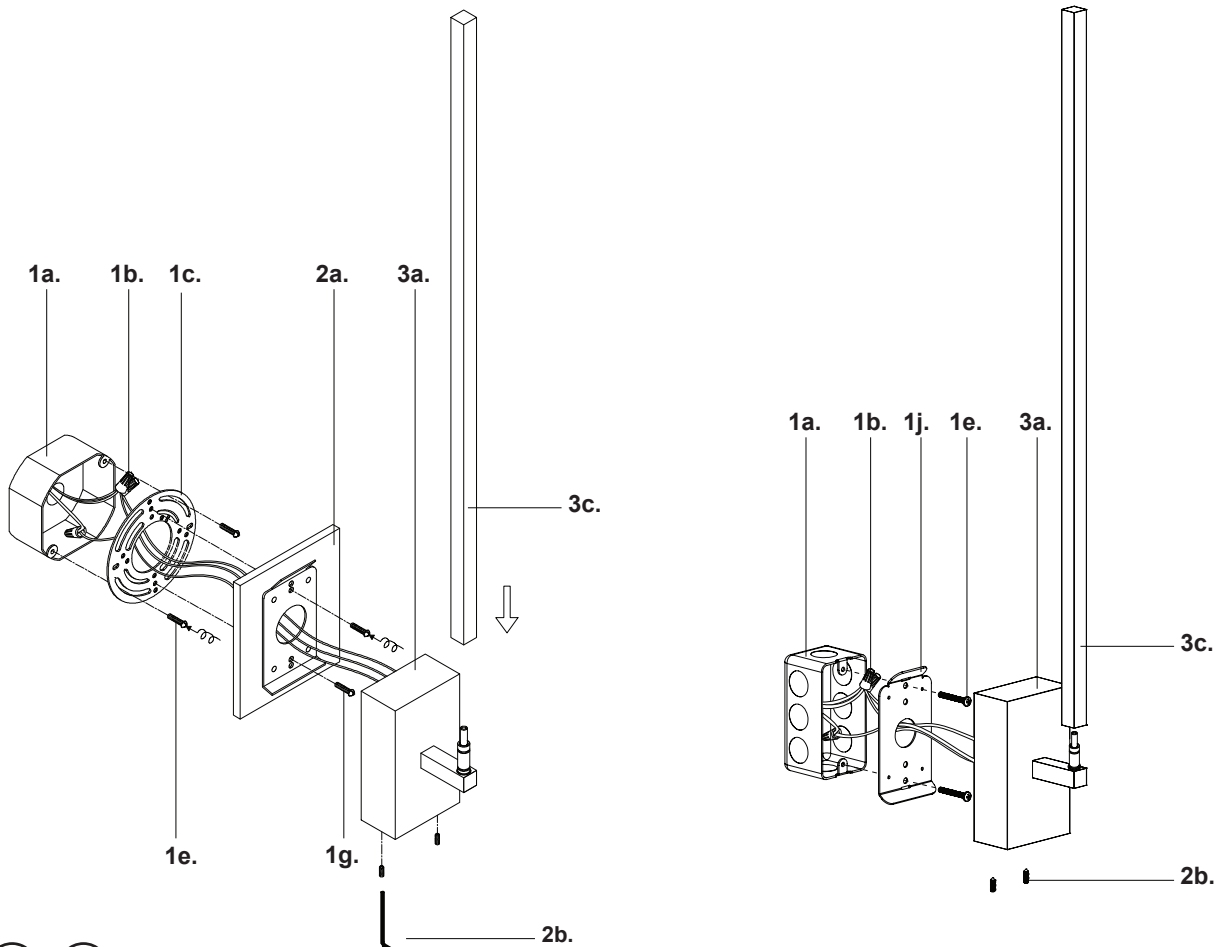

KUZCO

19054 28th Avenue Surrey, BC Canada V3Z 6M3
T: 604 538 7162 TF: 1-855 85 KUZCO F: 604 538 7196
W: kuzcolighting.com
20190910