

LED Flush Mount

FM48610

INSTALLATION SHEET

START FROM HERE

- Make sure power is completely off at the fuse box.
- Have your fixture installed by a qualified licensed electrician
- Prepare everything in a clear area.
- Wear gloves at all times during this installation.
- Read instructions carefully before you start assembly.
- Keep this instruction sheet for future reference.

Technical Support: 1-855-855-8926

Please Note:

- All Kuzco LED fixtures come with pre-wired LED module(s).
- Unless instructed to do so, please do not touch any part of the LED module(s) as any unnecessary contact with the module could cause permanent damage.
- For dimming, an ELV (Electronic Low Voltage) type of dimmer is required.

- 1.** Remove the fixture from its original packaging.
- 2.** Next, separate the mounting plate (**1c**) and outer glass (**2b**) from the canopy (**2a**) by removing the decorative nuts (**2c**). Attach the mounting plate (**1c**) to the electrical junction box (**1a**) on the ceiling using the two screws (**1e**) provided in the hardware package.
- 3.** You are now ready to mount the canopy (**2a**) and glass (**2b**) to the mounting plate (**1c**). First connect all wires correctly black to black "L", white to white "N" and the ground wire with provided marrettes (**1b**) from the hardware package.
- 4.** Align the holes in the canopy (**2a**) and glass (**2b**) to the threaded studs (**1d**) and push them up towards the mounting plate (**1c**). Next, screw in the two decorative nuts (**2c**) onto the threaded studs (**1d**), this will secure the canopy (**2a**) and glass (**2b**) to the mounting plate (**1c**).
- 5.** Attach the glass cover (**2d**) onto the canopy (**2a**) by threading the glass clockwise.

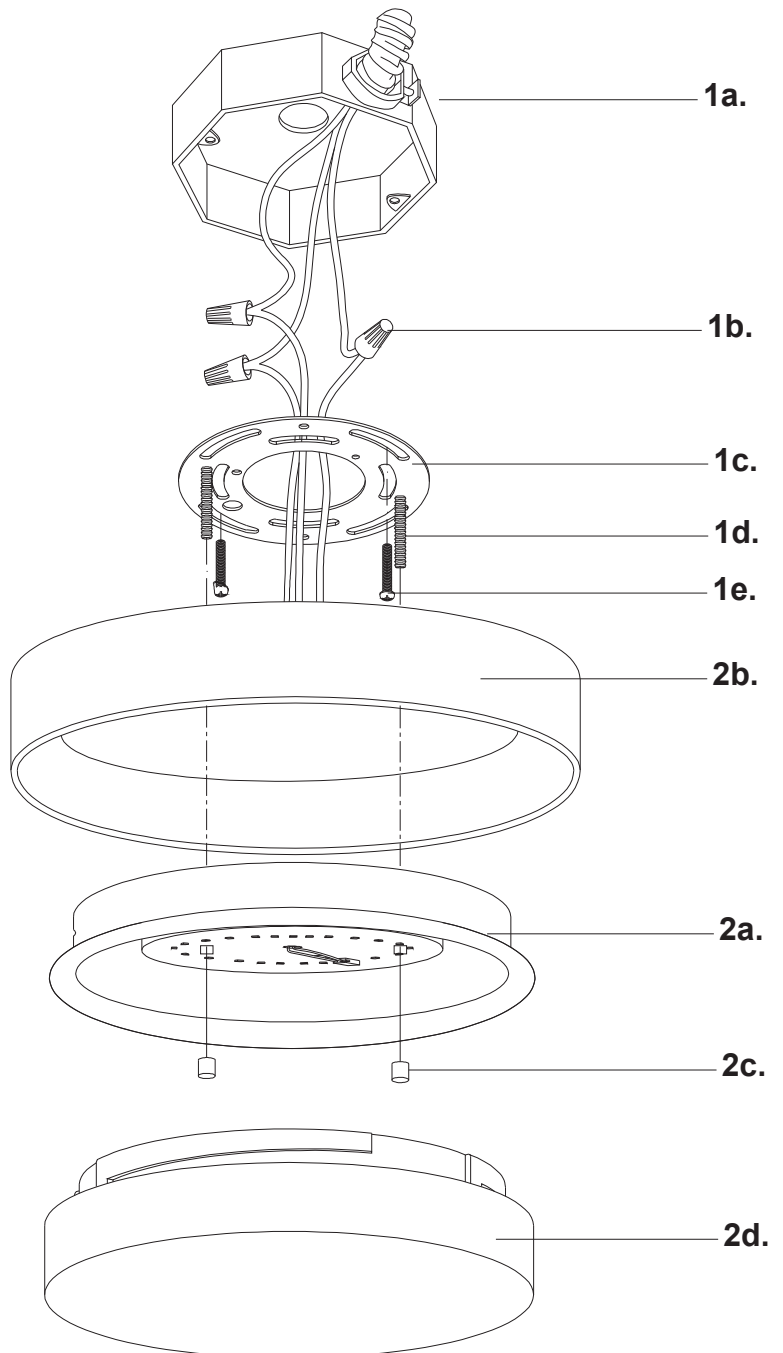

KUZCO

19054 28th Avenue Surrey, BC Canada V3Z 6M3
T: 604 538 7162 TF: 1-855 85 KUZCO F: 604 538 7196
W: kuzcolighting.com
20200805