

LED Flush Mount

FM10705
INSTALLATION SHEET

START FROM HERE

- Make sure power is completely off at the fuse box.
- Have your fixture installed by a qualified licensed electrician
- Prepare everything in a clear area.
- Wear gloves at all times during this installation.
- Read instructions carefully before you start assembly.
- Keep this instruction sheet for future reference.

Technical Support: 1-877-452-6858

Please Note:

- All Kuzco LED fixtures come with pre-wired LED module(s).
- Unless instructed to do so, please do not touch any part of the LED module(s) as any unnecessary contact with the module could cause permanent damage.
- For dimming, an ELV (Electronic Low Voltage) type of dimmer is required.

- 1.** Remove the fixture from its original packaging. Next, remove the canopy mounting plate (1b) from within the canopy (1d) by un-threading the two screws (2b).
- 2.** You are now ready to mount the canopy to the mounting plate. First connect all wires (1c) correctly black to black "L", white to white "N" and the ground wire with provided marrets from the hardware package. Align the mounting plate (1b) with the two holes on the surface of the canopy (2d). Next, screw in the two screws (1e) on to the mounting plate (1b), this will secure the canopy to the mounting plate.
- 3.** Connect the LED housing (2c) to the canopy (1d) using the two screws (2b). Now, lift the LED cowl (2d) up to the LED housing (2b) and thread clockwise.
- 4.** You have now completed the installation of your fixture, enjoy.

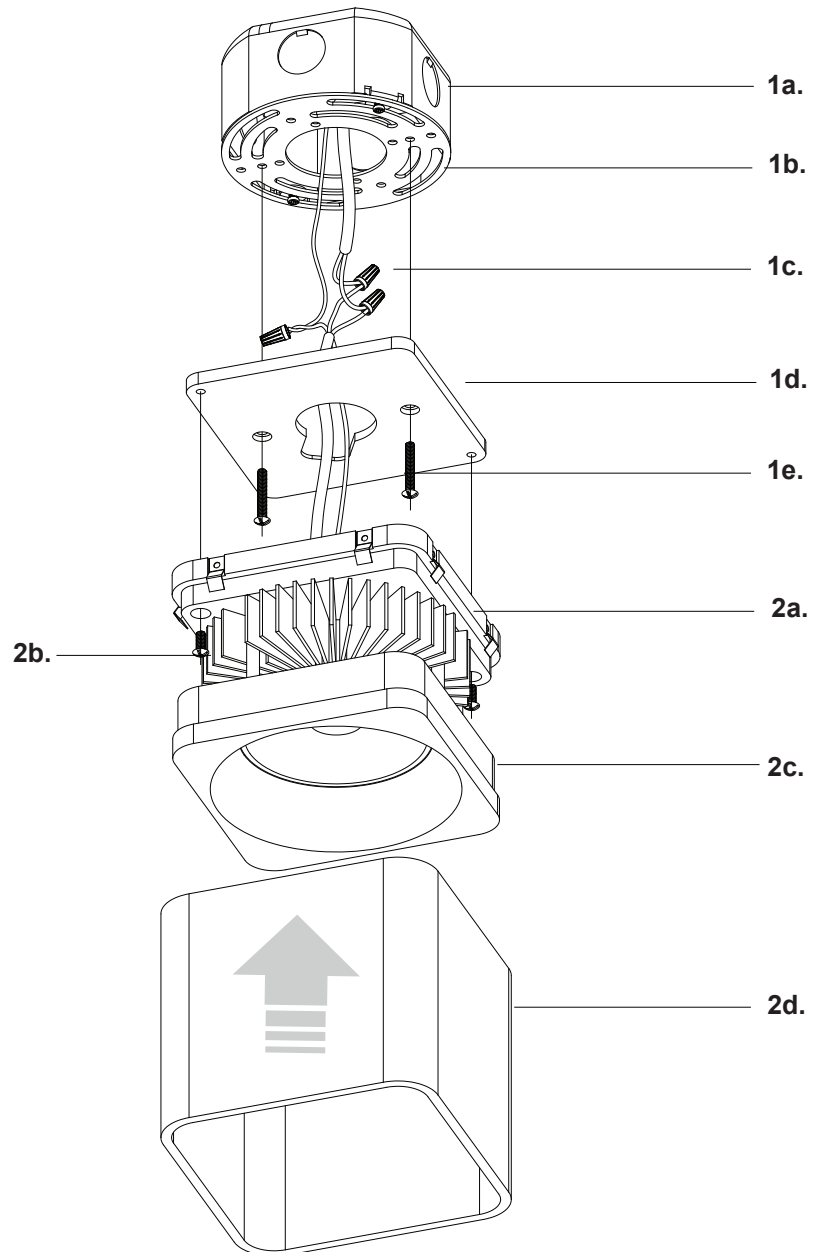

KUZCO
LIGHTING

19054 28th Avenue Surrey, BC Canada V3S 6M3
T: 604 538 7162 TF: 1-855 85 KUZCO F: 604 538 7196
W: kuzcolighting.com
20160527