

Ceiling Pendant

81711
INSTALLATION SHEET

START FROM HERE

- Make sure **POWER** is **COMPLETELY OFF** at the fuse box
- Have your fixture installed by a qualified licensed electrician
- Prepare everything in a clear area
- Wear gloves at all time during this installation
- Read instructions carefully before you start assembly
- Keep this installation sheet for future reference

Technical Support: 1-855-855-8926

- 1.** Remove fixture from its original package
- 2.** Separate mounting plate (1c) from canopy (2a) by removing decorative nuts (2c)
- 3.** Align mounting plate screws (1d) to desired orientation, and then attach mounting plate (1c) to electrical junction box (1a) using screws provided (1e) in hardware package
- 4.** Determine hanging height of fixture by securing rods (2d) to RTN (2e) and pendant body (3a)
- 5.** For wall mount, overall fixture length must not exceed 18"
- 6.** Make proper electrical connections (black to hot "L", white to neutral "N", ground to "GND") with wire nuts (1b) provided in hardware package
- 7.** Align and insert mounting plate screws (1d) through holes on canopy (2a), secure with decorative nuts (2c)
- 8.** Insert lamp (3g) into socket inside fixture body (3a), secure with lamp holder (3h)

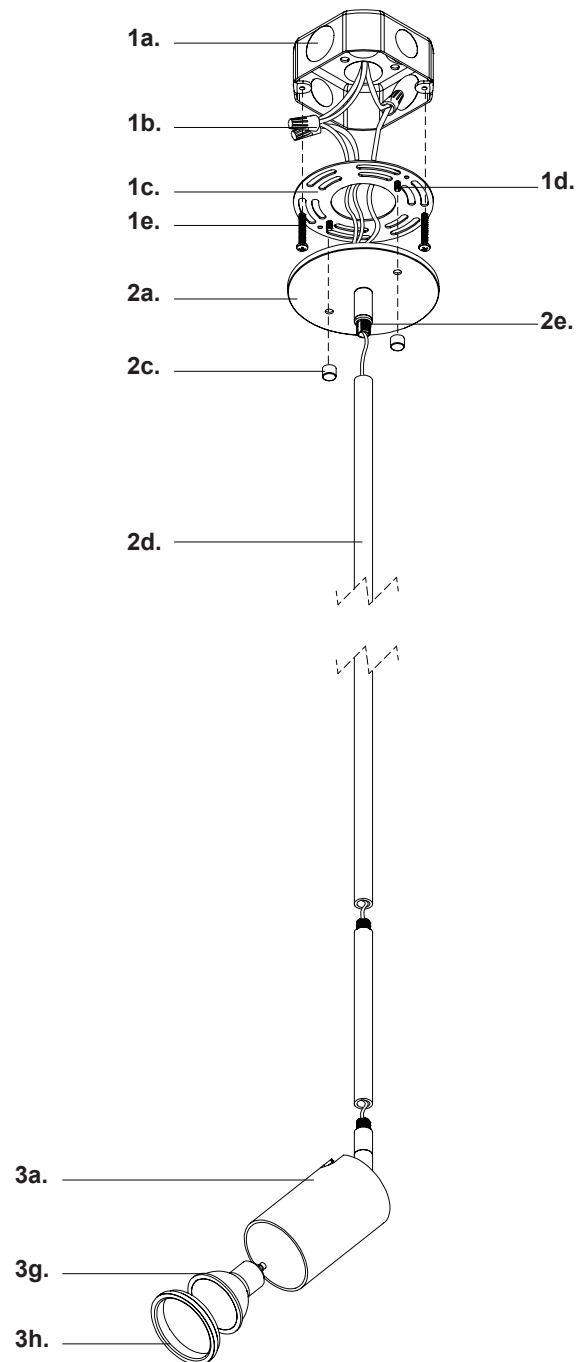

KUZCO

19054 28th Avenue Surrey, BC Canada V3Z 6M3
T: 604 538 7162 TF: 1-855 85 KUZCO F: 604 538 7196
W: kuzcolighting.com
20190909