

# Gimbal Recessed Lights - CCT Tunable

**CCT adjustable between 2700K, 3000K, 3500K, 4000K and 5000K.**

*Multiple styles, the lights are the perfect choice for residential or commercial lighting applications.*

*Ideal for sloped ceilings, wall washing, highlight artwork, task or general lighting etc.*





## Styles

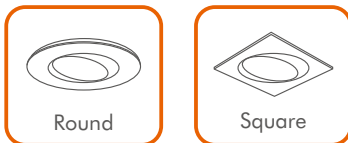

## Trim Options



## Sizes

2" Round Ø65mm	2" Square 65x65mm	3" Round Ø85mm	3" Square 85x85mm	4" Round Ø125mm	4" Square 125x125mm	4" Round Ø125mm	4" Square 125x125mm	6" Round Ø175mm
<b>5W</b>	<b>5W</b>	<b>8W</b>	<b>8W</b>	<b>11W</b>	<b>11W</b>	<b>12W</b>	<b>12W</b>	<b>15W</b>
400Lm	400Lm	600Lm	600Lm	1000Lm	1000Lm	1000Lm	1000Lm	1200Lm

## Features

- **Adjustable CCT: 2700K, 3000K, 3500K, 4000K or 5000K**
- Durable aluminum body with adjustable gimbal
- It is a high-performance, easy to install residential or commercial grade downlight solution that offers good light output, energy-efficiency and streamlined design
- Input voltage: AC 120V 50/60Hz
- Fast & easy to install-save on labour
- Tilting gimbal light source for directional lighting
- I.C. rated for direct contact with insulation
- No housing required
- LED technology fits anywhere you need general light source
- Color rendering index: 80
- 100%-10% dimming capability, this fixture is compatible with industry standard TRIAC/ELV dimmers
- Lifetime rated for greater than 50,000 hours
- Beam angle: 40°



## Dimensions

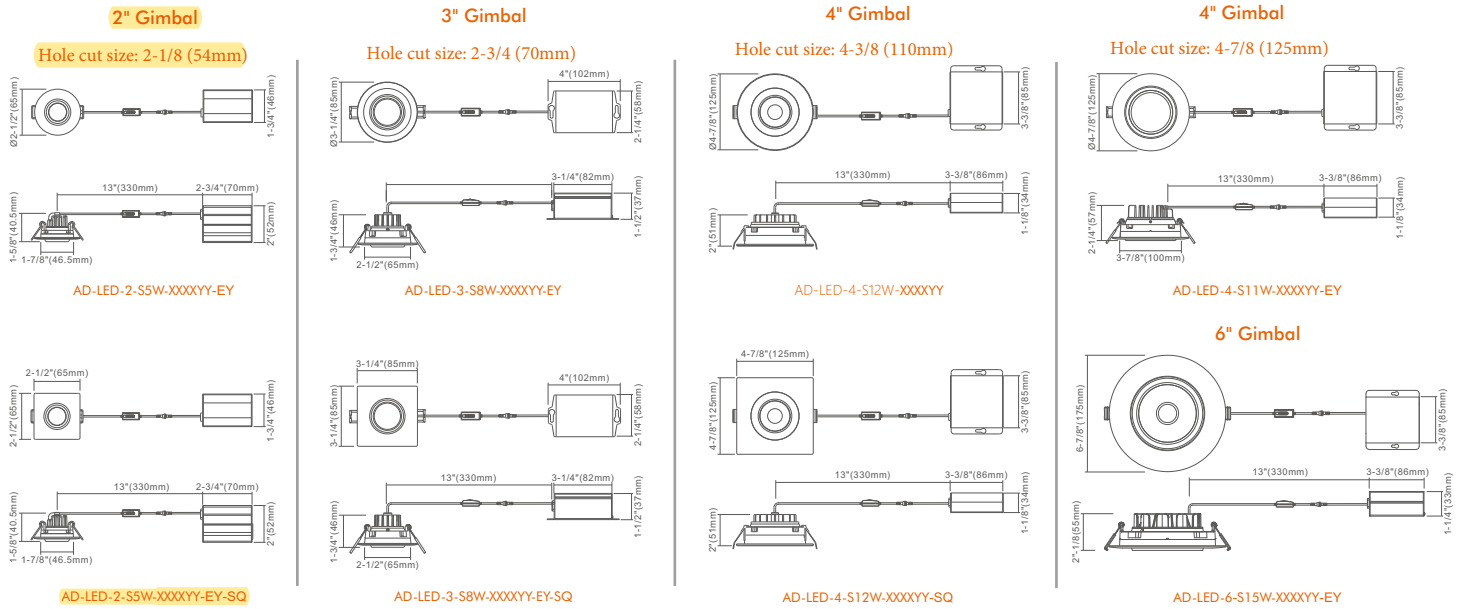



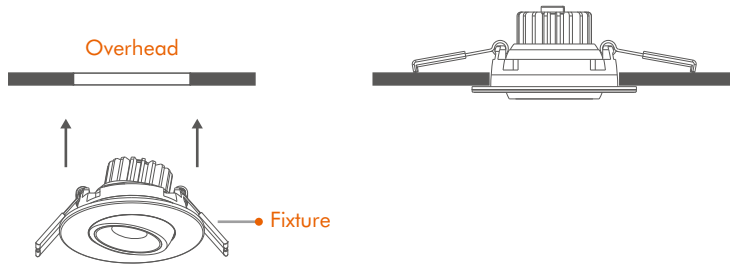

## Installation (Spring Clips)

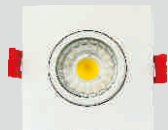

## Ordering Guide

Picture	Model	Description
	2" LED Gimbal Round	
	2" LED Gimbal Square	
	3" LED Gimbal Round	
	AD-LED-2-S5W-XXXXYY-EY	2" 5W Round Gimbal 30° tilting
	AD-LED-2-S5W-XXXXYY-EY-SQ	2" 5W Square Gimbal 30° tilting
	AD-LED-3-S8W-XXXXYY-EY	3" 8W Round Gimbal 30° Tilting

Picture	Model	Description
	<b>3" LED Gimbal Square</b>	
	AD-LED-3-S8W-XXXXYY-EY-SQ	3" 8W Square Gimbal 30° Tilting
	<b>4" LED Gimbal Round</b>	
	AD-LED-4-S11W-XXXXYY-EY	4" 11W Round Gimbal 30° Tilting
	<b>4" LED Flat Gimbal Round</b>	
	AD-LED-4-S12W-XXXXYY	4" 12W Round Gimbal 30° Tilting
	<b>4" LED Flat Gimbal Square</b>	
	AD-LED-4-S12W-XXXXYY-SQ	4" 12W Square Gimbal 30° Tilting
	<b>6" LED Gimbal Round</b>	
	AD-LED-6-S15W-XXXXYY	6" 15W Round Gimbal 30° Tilting

\* XXXX denotes different CCT,  
 27K for 2700K; 3K or 30K for 3000K;  
 35K for 3500K; 4K or 40K for 4000K;  
 5K or 50K for 5000K; 6K or 60K for 6000K;  
 3CCT for 3CCT Tunable; 5CCT for 5CCT Tunable

\* YY denotes different color finish  
 WH for White;  
 BN for Brushed Nickel;  
 BK for Black;  
 BZ for Oil Rubbed Bronze

### Accessories



Driver	
HBL008-120-D	2" 120Vac 5W Downlight Driver
HBL008-120-D	3" 120Vac 8W Downlight Driver
HBL012-120-D	4" 120Vac 12W Driver
HBL015-120-D	6" 120Vac 15W Driver