

# LED EDGE LIT CEILING LUMINAIRE INSTALLATION INSTRUCTIONS

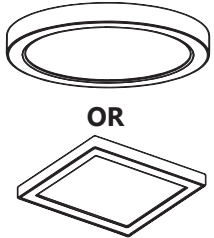

## COMPONENTS



LED Ceiling Light

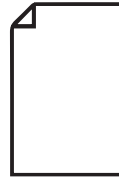

1 x Instructions Sheet

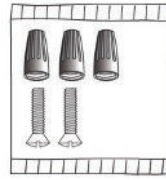

Hardware Kit

## TOOLS REQUIRED

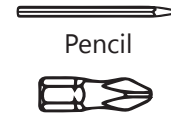

Pencil  
PZ1 Screw



Hole Opener

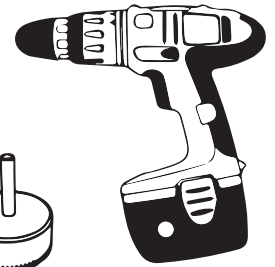

Power Drill

## IMPORTANT - READ ALL INSTRUCTIONS BEFORE INSTALLATION

- Installation and maintenance must be performed by a licensed electrician only.
- To avoid risk of electric shock, make sure to turn off main power switch prior to installation or maintenance.
- Must be installed in compliance with National Electrical Code (NEC) in the US or Canadian Electrical Code in Canada.
- Ensure input voltage and frequency are compatible with the fixture. Check product manual for power requirements prior to installation.

## WARNING: RISK OF ELECTRIC SHOCK. SUITABLE FOR WET LOCATIONS. RISK OF FIRE. USE ONLY ON 120 VOLT 60HZ CIRCUITS.

- Must be grounded
- Minimum 90 °C supply conductors
- Surface mounted
- This product must be installed in accordance with the applicable installation code by a person familiar with the construction and operation of the product and the hazards involved.
- The outlet box should be covered. This fixture is designed for use in a circuit protected by a fuse or circuit breaker.

## MAINTENANCE AND CARE

1. Clean and maintain the luminaire regularly
2. When cleaning, use a soft cloth with non-abrasive detergent and wipe dry with a clean soft cloth
3. Do not use any cleaners that contain alcohol, harsh chemicals or pesticides
4. When cleaning inside the luminaire, turn off the power, and do not spray liquid cleaner directly on the LEDs, LED driver or wiring.

## HOW TO INSTALL (MOUNTING AND ELECTRICAL)

1. Read these instructions carefully before attempting to install this product.
2. Disconnect electrical power before installing or servicing any part of this fixture.
3. Place fixture on a clean flat surface.

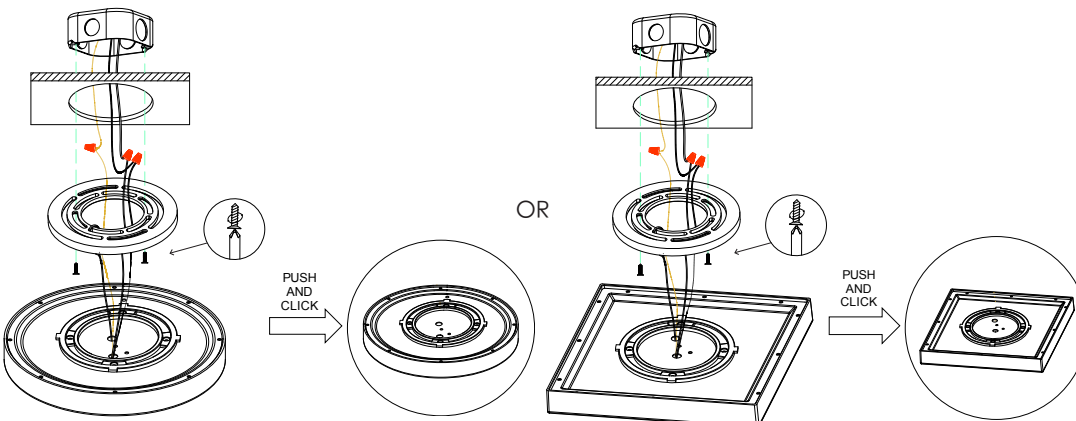

## WIRING GUIDE

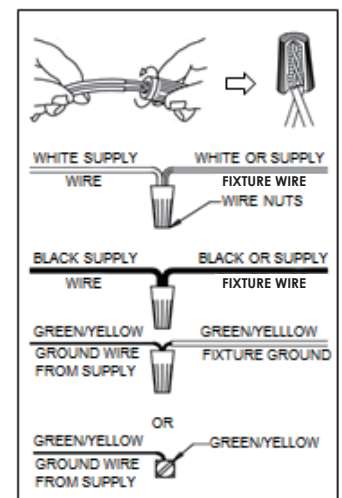

Dimmable to 10% with most dimmers. Although this product is compatible with most common residential type dimmers, dimming performance varies from dimmer to dimmer. Dimmer settings (for dimmers with brightness range adjustments) and the number of LED modules installed on the circuit can affect dimming performance. For more information including dimmer compatibility visit [www.standardpro.com](http://www.standardpro.com)